



X3-HYB-G4 PRO

4 kW / 5 kW / 6 kW / 8 kW / 10 kW / 12 kW / 15 kW

User Manual

Version 1.0

www.solaxpower.com



eManual in the QR code or
at <http://kb.solaxpower.com/>

STATEMENT

Copyright

Copyright © SolaX Power Network Technology (Zhejiang) Co., Ltd. All rights reserved.

No part of this manual may be reproduced, transmitted, transcribed, stored in a retrieval system, or translated into any language or computer language, in any form or by any means without the prior written permission of SolaX Power Network Technology (Zhejiang) Co., Ltd.

Trademarks



SOLA^X and other symbol or design (brand name, logo) that distinguishes the products or services offered by SolaX has been trademark protected. Any unauthorized use of the above stated trademark may infringe the trademark right.

Notice

Please note that certain products, features, and services mentioned in this document may not be within the scope of your purchase or usage. Unless otherwise specified in the contract, the contents, information, and recommendations presented in this document are provided "as is" by SolaX. We do not provide any warranties, guarantees, or representations, whether express or implied.

The content of the documents is reviewed and updated as needed. However, occasional discrepancies may occur. SolaX retains the right to make improvements or changes in the product(s) and the program(s) described in this manual at any time without prior notice.

The images included in this document are solely for illustrative purposes and may differ based on the specific product models.

For more detailed information, kindly visit the website of SolaX Power Network Technology (Zhejiang) Co., Ltd. at www.solaxpower.com.

SolaX retains all rights for the final explanation.

About This Manual

Scope of Validity

This manual is an integral part of X3-HYB-G4 PRO series inverter. It describes the transportation, storage, installation, electrical connection, commissioning, maintenance and troubleshooting of the product. Please read it carefully before operating.

This manual is valid for the following inverter models:

- X3-HYB-4.0-P
- X3-HYB-5.0-P
- X3-HYB-6.0-P
- X3-HYB-8.0-P
- X3-HYB-10.0-P
- X3-HYB-12.0-P
- X3-HYB-15.0-P

Model description

X3-HYB-4.0-P

1

2

3

Item	Meaning	Description
1	Product family name	"X3-HYB": Three-phase energy storage series inverter that supports grid connection of photovoltaic system.
2	Power	"4.0": rated output power of 4 kW.
3	Professional	X3-HYB-G4 PRO series inverter is an upgrade from X3-Hybrid-G4 series inverter.

Target Group





The installation, maintenance and grid-related setting can only be performed by qualified personnel who:

- Are licensed and/or satisfy state and local regulations.

- Have good knowledge of this manual and other related documents.

Conventions

The symbols that may be found in this manual are defined as follows.

Symbol	Description
 DANGER	Indicates a hazardous situation which, if not avoided, will result in death or serious injury.
 WARNING	Indicates a hazardous situation which, if not avoided, could result in death or serious injury.
 CAUTION!	Indicates a hazardous situation which, if not avoided, could result in minor or moderate injury.
 NOTICE!	Provides tips for the optimal operation of the product.

Change History

Version 1.0 (2024-08-13)

Added steps for installing a wire shielding cover to ["7 Mechanical Installation"](#) and updated the packing list.

Modified the contact information about Australia service.

Marked CT as optional and add description on how to identify it through the label on the packaging.

Table of Contents

1	Safety	1
1.1	General Safety	1
1.2	Safety Instructions of PV, Inverter and Grid	2
1.2.1	Safety Instructions of PV	2
1.2.2	Safety Instructions of Inverter	2
1.2.3	Safety Instructions of Utility Grid	3
2	Product Overview	4
2.1	Product Introduction	4
2.2	Appearance	4
2.3	Supported Power Grid	5
2.4	Symbols on the Label and Inverter	6
2.5	Working Principle	7
2.5.1	Circuit Diagram	7
2.5.2	Application Schemes	8
2.6	Working State	12
2.7	Working Mode	14
2.7.1	Self use Mode (Priority: Loads>Battery>Grid)	14
2.7.2	Feed-in Priority (Priority: Loads>Grid)	16
2.7.3	Backup Mode (Priority: Loads>Battery>Grid)	17
2.7.4	Peak Shaving Mode	19
2.7.5	TOU Mode	20
2.7.6	EPS Mode (Priority: Loads>Battery)	20
2.7.7	Manual Mode	22
2.7.8	Export Control Function	22
3	System Overview	23
4	Transportation and Storage	26
5	Preparation before Installation	27
5.1	Selection of Installation Location	27
5.1.1	Environment Requirement	27
5.2	Installation Carrier Requirement	29
5.2.1	Clearance Requirement	29
5.3	Tools Requirement	31
5.4	Additionally Required Materials	32

6	Unpacking and Inspection	34
6.1	Unpacking.....	34
6.2	Scope of Delivery.....	35
7	Mechanical Installation	38
7.1	Dimensions for mounting.....	39
7.2	Installation procedures.....	39
8	Electrical Connection	45
8.1	Overview of Electrical Connection.....	45
8.1.1	Ports and Parts of Inverter.....	45
8.1.2	Cable Connections of Inverter.....	47
8.2	PE Connection	49
8.3	AC Connection.....	52
8.4	PV Connection	59
8.5	Battery Power Cable Connection.....	64
8.6	COM 1 Communication Connection	68
8.6.1	Pin Assignment of Port COM 1.....	69
8.6.2	Meter/CT Connection.....	70
8.6.3	RS485 Communication Connection	74
8.6.4	BMS Communication Connection	75
8.6.5	Parallel Connection.....	76
8.7	COM 2 Communication Connection.....	77
8.7.1	Pin Assignment of Port COM 2	78
8.7.2	Datahub, heatpump, and EVC communication connection	79
8.7.3	DI/DO Communication Connection	83
8.7.4	V2X Connection	85
8.7.5	DRM & Ripple Control Connection	86
8.8	Monitoring Connection.....	89
9	System Commissioning	92
9.1	Checking before Power-on	92
9.2	Powering on the System.....	92
9.3	DC Switch	93
10	Operation on LCD.....	96
10.1	Introduction of Control Panel.....	96
10.2	Introduction of Menu Interface	98
10.3	System ON/OFF.....	101
10.4	Mode Select	101
10.5	System Status	101

10.6	History Data.....	103
10.7	Settings	105
10.7.1	User Settings.....	105
10.7.2	Advanced Settings.....	111
10.8	About.....	133
11	Operation on SolaX App and Web.....	134
11.1	Introduction of SolaXCloud.....	134
11.2	Operation Guide on SolaXCloud App	134
11.2.1	Downloading and Installing App	134
11.2.2	Operation on the App.....	135
11.3	Operations on SolaXCloud Webpage.....	135
12	Troubleshooting and Maintenance	136
12.1	Power off.....	136
12.2	Troubleshooting.....	136
12.3	Maintenance.....	146
12.3.1	Maintenance Routines.....	146
12.3.2	Upgrading Firmware.....	148
13	Decommissioning.....	150
13.1	Disassembling the Inverter	150
13.2	Packing the Inverter	153
13.3	Disposing of the Inverter	153
14	Technical Data	154
15	Appendix	160
15.1	Application of Generator.....	160
15.1.1	Introduction of Generator Application	160
15.1.2	Notice for Generator Application.....	160
15.1.3	ATS Control Mode.....	160
15.1.4	Dry Contact Mode.....	162
15.2	Application of Adapter Box G2	166
15.2.1	Introduction of Adapter Box G2 Application.....	166
15.2.2	Wiring Connection Diagram.....	166
15.2.3	Communication Connection with Inverter.....	167
15.2.4	Settings for Adapter Box G2.....	168
15.3	Application of EV-Charger	169
15.3.1	Introduction of EV-Charger Application	169
15.3.2	Wiring Connection Diagram.....	169
15.3.3	Charging Modes.....	169

15.3.4	Communication Connection with Inverter.....	170
15.3.5	Settings for EV-Charger.....	171
15.4	Application of DataHub	172
15.4.1	Introduction of DataHub Application.....	172
15.4.2	Wiring Connection Diagram.....	172
15.4.3	Communication Connection with Inverter.....	173
15.4.4	Settings for DataHub.....	174
15.5	Application of Micro-grid	175
15.5.1	Introduction of Micro-grid Application.....	175
15.5.2	Wiring Connection Diagram.....	175
15.5.3	Working Modes.....	176
15.5.4	Cable Connection (Hybrid inverter).....	178
15.5.5	Cable Connection (On-grid inverter)	178
15.5.6	Cable Connection (Meter)	178
15.6	Application of Parallel Function	181
15.6.1	Introduction of Parallel Application	181
15.6.2	Notice for Parallel Application.....	181
15.6.3	System Wiring Diagram	182
15.6.4	System Wiring Procedure.....	184
15.6.5	Settings for Parallel Connection.....	187
15.7	CT/Meter Connection Scenarios	189
15.7.1	Connection of CT	189
15.7.2	Connection of Direct-connected Meter	192
15.7.3	Connection of CT-connected Meter	195
15.7.4	Connection of Two Meters	198

1 Safety

1.1 General Safety

The series inverter has been meticulously designed and thoroughly tested to comply with the relevant state and international safety standards. Nevertheless, like all electrical and electronic equipment, safety precautions must be observed and followed during the installation of the inverter to minimize the risk of personal injury and ensure a safe installation.

Please thoroughly read, comprehend, and strictly adhere to the comprehensive instructions provided in the user manual and any other relevant regulations prior to the installation of the inverter. The safety instructions in this document serve as supplementary guidelines to local laws and regulations.

SolaX shall not be liable for any consequences resulting from the violation of the storage, transportation, installation, and operation regulations outlined in this document. Such consequences include, but are not limited to:

- Inverter damage caused by force majeure events, such as earthquakes, floods, thunderstorms, lightning, fire hazards, volcanic eruptions, and similar events.
- Inverter damage due to human causes.
- Usage or operation of the inverter in violation of local policies or regulations.
- Failure to comply with the operation instructions and safety precautions provided with the product and in this document.
- Improper installation or usage of the inverter in unsuitable environmental or electrical conditions.
- Unauthorized modifications to the product or software.
- Inverter damage occurring during transportation by the customer.
- Storage conditions that do not meet the requirements specified in this document.
- Installation and commissioning performed by unauthorized personnel who lack the necessary licenses or do not comply with state and local regulations.

1.2 Safety Instructions of PV, Inverter and Grid

Save these important safety instructions. Failure to follow these safety instructions may result in damage to the inverter and injury or even loss of life.

1.2.1 Safety Instructions of PV

DANGER!

Potential risk of lethal electric shock associated with the photovoltaic (PV) system

- Exposure to sunlight can result in the generation of high DC voltage by PV modules, which can lead to electric shock causing severe injuries or even death.
- Never touch the positive or negative poles of the PV connecting device, and avoid touching both poles simultaneously.
- Do not ground the positive or negative poles of the PV modules.
- Only qualified personnel can perform the wiring of the PV modules.

WARNING!

- Overvoltage protection with surge arresters should be provided when the PV system is installed. The inverter is fitted with SPDs on both PV input side and MAINS side.
- Please consult professionals before installing SPDs.

WARNING!

- Make sure that the input DC voltage does not exceed the maximum DC input voltage specified for the inverter. Overvoltage can cause irreversible damage to the inverter, and such damage is not covered by the warranty.

1.2.2 Safety Instructions of Inverter

DANGER!

Potential risk of lethal electric shock associated with the inverter

- Only operate the inverter if it is in a technically faultless condition. Operating a faulty inverter may lead to electric shock or fire.
- Do not attempt to open the enclosure without authorization from SolaX. Unauthorized opening of the enclosure will void the warranty and can result in lethal danger or serious injury due to electric shock.
- Make sure that the inverter is reliably grounded before any operation to prevent the risk of electric shock causing lethal danger or serious injury.
- Only qualified personnel can perform the installation, wiring, maintenance of the inverter by following this document and the related regulations.

WARNING!

- During operation, avoid touching any parts of the inverter other than the DC switch and LCD panel (if any).
- Never connect or disconnect the AC and DC connector while the inverter is running.
- Prior to conducting any maintenance, turn off the AC and DC power and disconnect them from the inverter. Wait for 5 minutes to fully discharge the energy.

WARNING!**Potential danger of scalding due to the hot enclosure of the inverter**

- Avoid touching the inverter while it is running, as it becomes hot during operation and may cause personal injuries.

WARNING!

- When handling the battery, carefully follow all safety instructions provided in the battery manual. The battery used with the inverter must meet the specified requirements of the series inverter.

WARNING!

- Use insulated tools when installing the device, and always wear personal protective equipment during installation and maintenance.

CAUTION!

- Make sure that children are supervised to prevent them from playing with the inverter.
- Pay attention to the weight of the inverter and handle it properly to avoid personal injuries.

NOTICE!

- If an external Residual Current Device (RCD) is required by local regulations, verify the type of RCD required. It is recommended to use a Type-A RCD with a rating of 300 mA. When required by local regulations, the use of a Type-B RCD is permitted.
- Keep all product labels and the nameplate on the inverter clearly visible and well-maintained.

1.2.3 Safety Instructions of Utility Grid

NOTICE!

- Only connect the inverter to the grid with the permission of the local utility grid company.

2 Product Overview

2.1 Product Introduction

The X3-HYB-G4 PRO series is an energy storage PV grid-connected inverter. It supports various intelligent solutions such as load management, wireless metering, dual battery terminals, and microgrids, to achieve efficient and economical energy utilization. The X3-HYB-G4 PRO series inverter can be used with SolaX batteries in different models.

2.2 Appearance

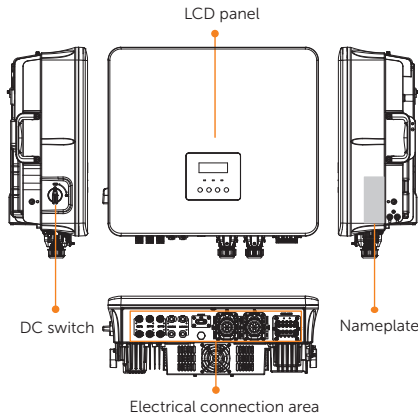

Figure 2-1 Appearance

Table 2-1 Description of appearance

Item	Description
Nameplate	Nameplate clearly shows the device type, serial number, DC / AC parameters, certification, etc.
LCD panel	Including screen, indicators and keys. The screen displays the device running information. The indicators show the status of inverter. The keys are used to set parameters.
DC switch	Disconnect the DC input when necessary.
Electrical connection area	Including MPPT ports, battery ports, Grid & EPS port, communication ports, etc.

2.3 Supported Power Grid

There are different ways of wiring for different grid systems. TT / TN-S / TN-C-S are shown as below:

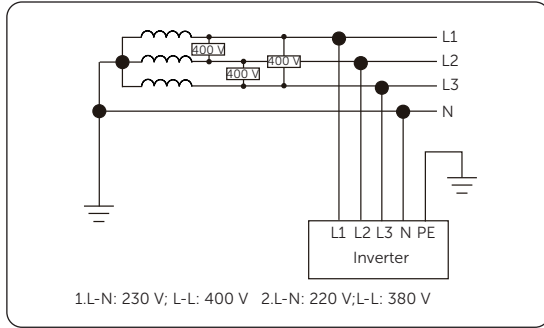

Figure 2-2 Supported power grid-TT

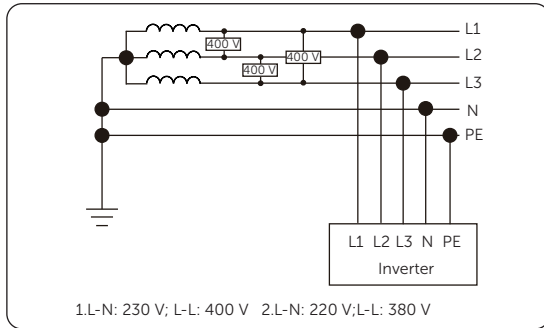

Figure 2-3 Supported power grid-TN-S

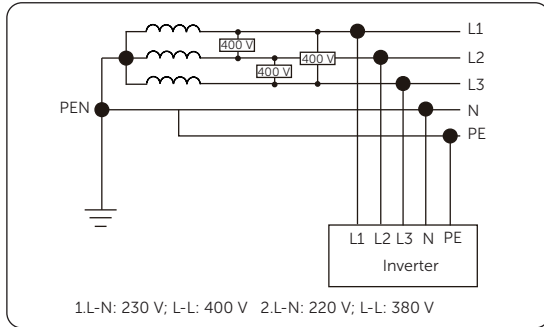













Figure 2-4 Supported power grid-TN-C-S

2.4 Symbols on the Label and Inverter

Table 2-2 Description of symbols

Symbol	Description
	CE mark. The inverter complies with the requirements of the applicable CE guidelines.
	TUV certified.
	RCM mark. The inverter complies with the requirements of the applicable RCM guidelines.
	Additional grounding point.
	Beware of hot surface. Do not touch a running inverter, as the inverter becomes hot during operation!
	Risk of electric shock. High voltage exists after the inverter is powered on!
	Risk of danger. Potential hazards exist after the inverter is powered on!
	Read the enclosed documentations.
	Do not dispose of the inverter together with household waste.
	Do not operate this inverter until it is isolated from battery, mains and on-site PV generation source.
	Danger of high voltage. Do not touch live parts until you have disconnected the inverter from the power sources for 5 minutes.

2.5 Working Principle

2.5.1 Circuit Diagram

The inverter is equipped with multi-channel MPPT for DC input to ensure maximum power even under different photovoltaic input conditions. The inverter unit converts direct current into alternating current that meets the requirements of the power grid and feeds it into the power grid. The working principle of inverter is shown below:

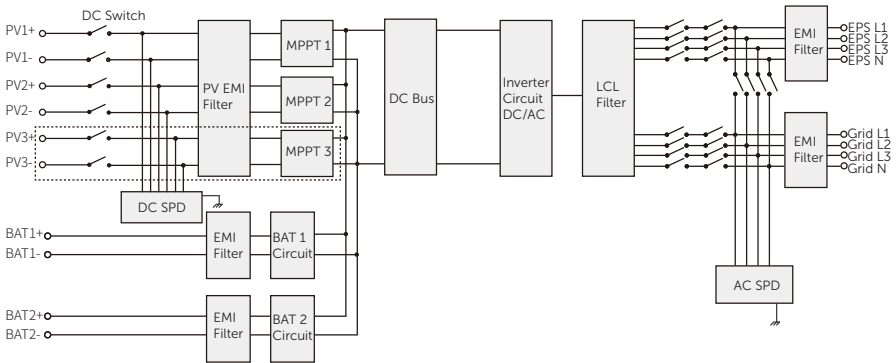

Figure 2-5 Circuit diagram of X3-HYB-G4 PRO series inverter

NOTICE!

- PV 3 in the dotted box is only available to 8 kW, 10 kW, 12 kW and 15 kW inverters.

2.5.2 Application Schemes

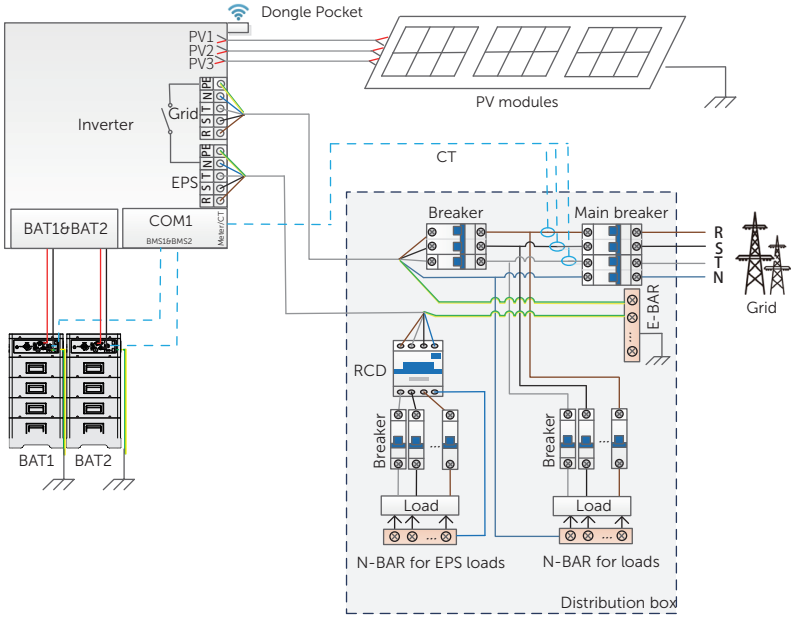

Figure 2-6 Application scheme without a matebox for most countries

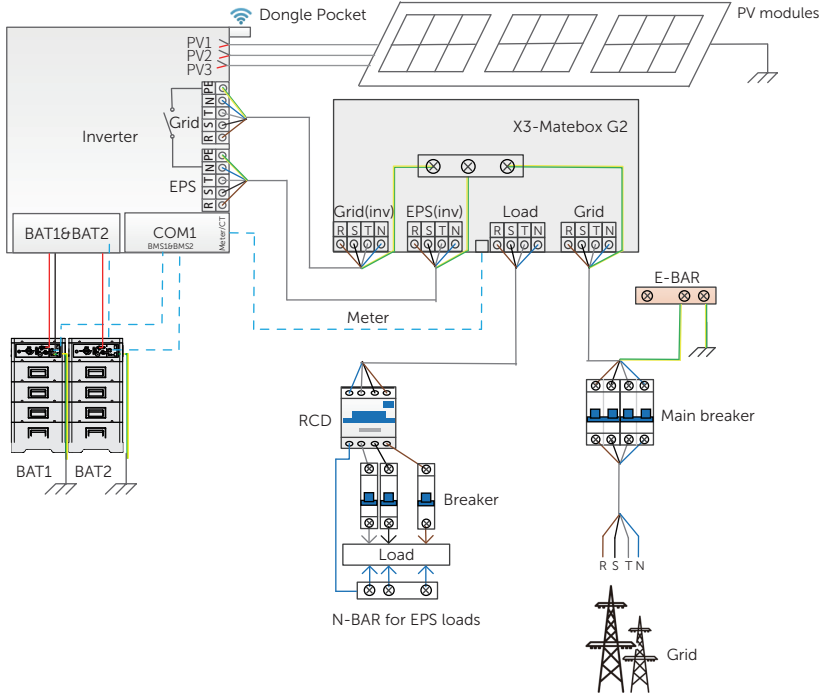

Figure 2-7 Application scheme with a matebox for most countries

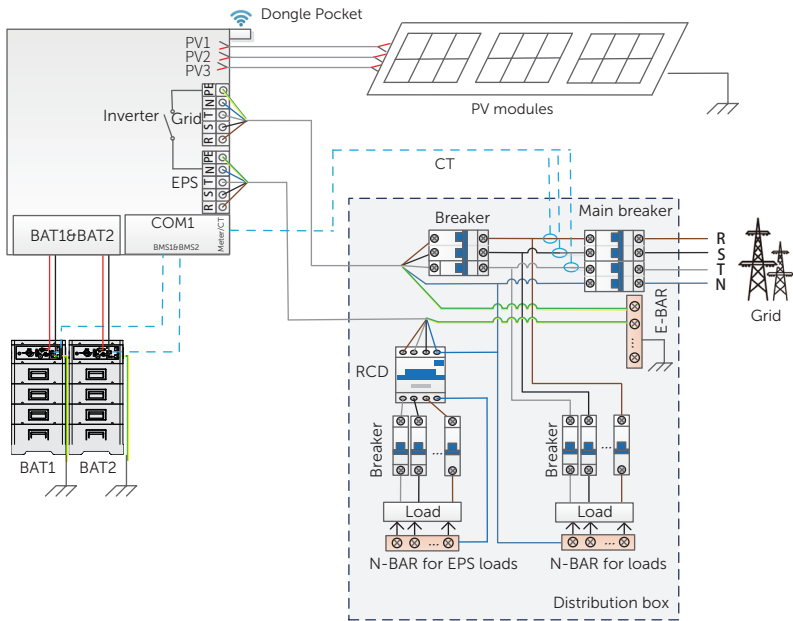

Figure 2-8 Application scheme without a matebox for Australia

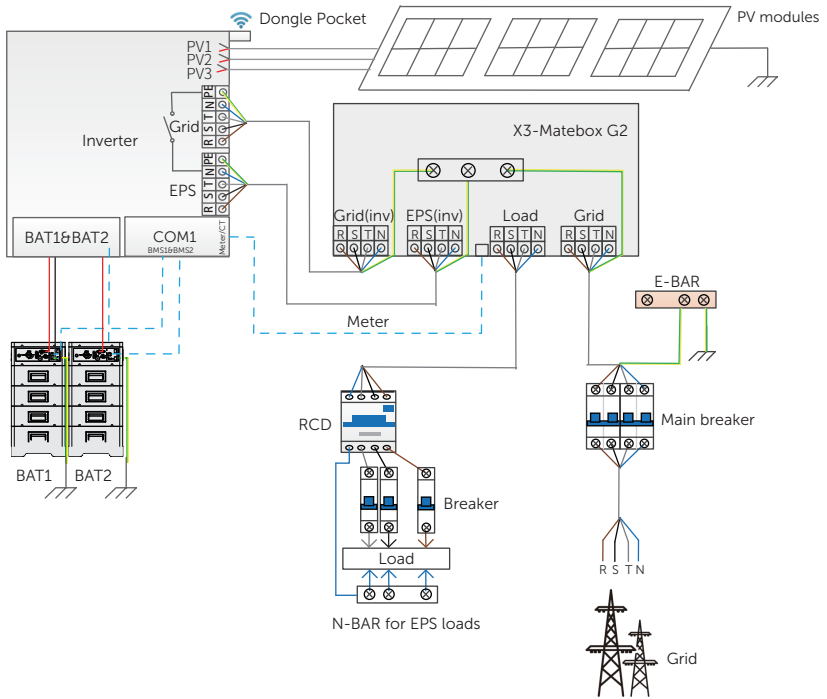

Figure 2-9 Application scheme with a matebox for Australia

2.6 Working State

The series inverter has 9 states: Waiting, Checking, Normal, EPS Checking, EPS, Fault, Idle, Standby and Abnormal Hibernate.

Table 2-3 Description of working state

State	Description
Waiting	<p>The inverter is waiting for the conditions to be met in order to enter Checking state. The conditions are:</p> <ul style="list-style-type: none"> the PV input voltage reaches the target value. the AC-side voltage and frequency meet the regulations of the grid.
Checking	<p>The inverter is checking for conditions to enter Normal state.</p>
Normal	<p>The inverter is working normally. The Normal state includes 3 situations: Normal (On-grid), Normal (R), and Normal (G).</p> <ul style="list-style-type: none"> Normal (On-grid): The inverter is connected to the public grid and works normally. Normal (R): The inverter is connected to the public grid and an external device controls the inverter remotely. Normal (G): After the inverter disconnected from the public grid, a generator is started to ensure that the inverter works normally.
EPS Checking	<p>The inverter is checking for conditions to enter EPS state.</p>
EPS	<p>The inverter is in off-grid state.</p>
Fault	<p>The inverter detects an error and reports the error code.</p>
Idle	<p>An inverter goes into idle state in the following conditions:</p> <ul style="list-style-type: none"> the battery SOC reaches the minimum value; and the battery hibernates for there is no sufficient PV input voltage.
Standby	<p>An inverter goes into standby state in either of the two situations:</p> <ul style="list-style-type: none"> when the power of load is extremely low and there is no sufficient PV input voltage, or when the battery SOC is larger than or equal to 10% and there is no sufficient PV input voltage. <p>In this state, the inverter will constantly detect PV connection, load power and others, to determine whether to exit from the Standby state and enter the Normal state again.</p>
Abnormal Hibernate	<p>The battery SOC is lower than the minimum value set before and the inverter detected a fault.</p>

NOTICE!

When a device is in idle state, you can wake up the device by setting the following through the device LCD or SolaX Cloud App:

- Re-set the working mode.
- Re-set the minimum battery SOC. It should be noted that: "the actual battery SOC — the re-set minimum battery SOC \geq 2%".
- Re-set the charging period.

2.7 Working Mode

When an inverter is in on-grid state, there are 6 working modes for you to select: Self use, Feed-in priority, Backup, Peak shaving, TOU, and Manual. You can choose one of them according to your lifestyle and environment.

When the power supply from the electric power company is cut off due to a power outage, the inverter will automatically switch to the EPS mode and connect to the distribution board for specific loads, thereby providing power to important loads.

For details about working mode setting, please refer to “10.7.1 User Settings”.

2.7.1 Self use Mode (Priority: Loads>Battery>Grid)

The self use mode is suitable for areas with low feed-in subsidies but high electricity prices. The power from PV supplies the loads first. After that, if there is surplus power, charge the battery first and then feed into the grid.

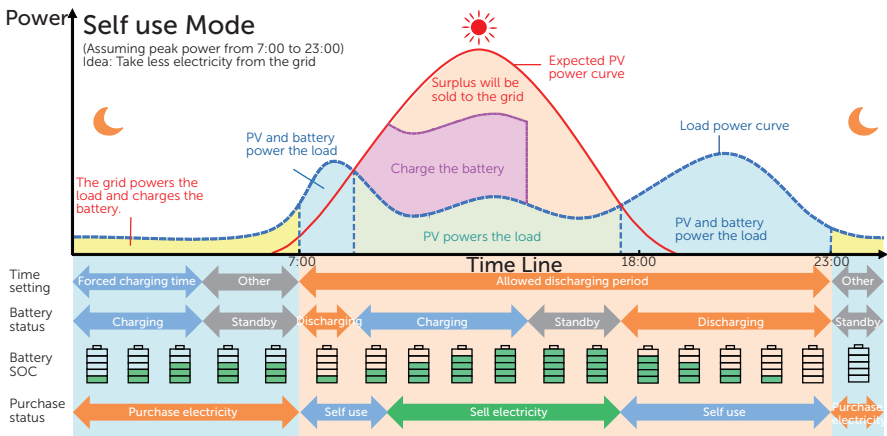

Figure 2-10 Self use mode

Table 2-4 Description of self use mode

Time period	Inverter working status
Forced charging period	Charge the battery first until the battery SOC reaches the specified value for Charge battery to . You can set whether the inverter draws power from the grid or not.

Time period	Inverter working status
Allowed discharging period	PV is sufficient (PV → load → battery → grid) <ul style="list-style-type: none"> The power generated from PV is supplied to the load first. After that, the remaining power is used to charge the battery. If there is still surplus electricity, it can be sold to the grid. It should be noted that, if the local utility restricts the sale of electricity to the grid, the Export Control value can be set for the inverter. Please refer to "Setting Export Control".
	PV is insufficient (PV+battery → load) <ul style="list-style-type: none"> The battery discharges, to supply power to the load. Once the remaining power reaches the Min SOC, the battery automatically stops discharging.

Note:

Charge battery to: The battery SOC charged from grid. 30% by default, the settable range is 10%~100%.

Min SOC: Minimum SOC of the battery under grid connection. 10% by default, the settable range is 10%~100%.

Export Control: The power exported to the grid. 300000 W by default, the settable range is from 0 to the rated output power.

Charge & Discharge Period

You can set two working periods: forced charging period and allowed discharging period. The other time except the charging & discharging period is defined as "other time periods".

- Forced charging period (Default period: 00:00~00:00, closed by default)

In the forced charging period, the inverter will charge the battery first until the battery SOC reaches the specified **Charge battery to** value set in each working mode. You can enable/disable the function of the inverter drawing power from the grid.

- Allowed discharging period (Default period: 00:00~23:59)

In the allowed discharging period, the inverter will allow the battery to discharge according to the working mode and load conditions.

- Other time periods

In other periods, the inverter can charge the battery but the battery cannot discharge power to others.

NOTICE!

- The charge & discharge period is only applicable to self use mode, feed-in priority and backup mode. The priority of forced charging period is higher than all working modes.

2.7.2 Feed-in Priority (Priority: Loads>Grid)

The feed-in priority mode is suitable for areas with high feed-in subsidies. The power generated from PV is supplied to the loads first. If there is power left, sell the remaining power to the grid.

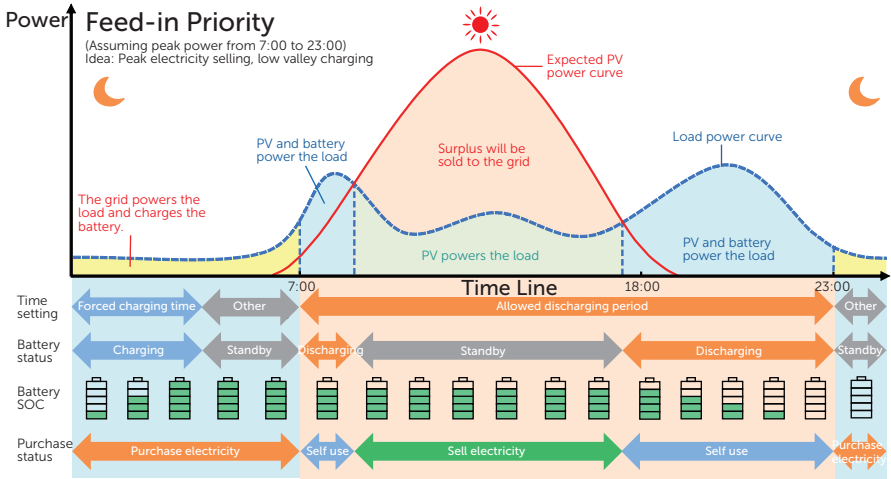

Figure 2-11 Feed-in priority

Table 2-5 Description of feed-in priority

Time period	Inverter working status
Forced charging period	<ul style="list-style-type: none"> Charge the battery first until the battery SOC reaches the specified value for Charge battery to. You can set whether the inverter draws power from the grid or not.
Allowed discharging period	PV is sufficient (PV → load → grid) <ul style="list-style-type: none"> The power generated from PV is directly supplied to the loads first. Any excess power beyond the load requirements will be fed into the grid.
	PV is insufficient (PV+battery → load) <ul style="list-style-type: none"> The PV and battery supply power to the loads at the same time. Once the remaining supply reaches the Min SOC, the battery automatically stops discharging.

Note:

Charge battery to: The battery SOC charged from grid. 50% by default, the settlable range is 10%~100%.

Min SOC: Minimum SOC of the battery under grid connection. 10% by default, the settlable

range is 10%~100%.

NOTICE!

- You can set two working periods: forced charging period and allowed discharging period. Please refer to “Charge & Discharge Period” for details.
- In feed-in priority mode, consider whether the battery can be charged during the daytime. If not, it is recommended to set forced charging period during off-peak hours.

2.7.3 Backup Mode (Priority: Loads>Battery>Grid)

The backup mode is suitable for areas with frequent power outages.

In this mode, the battery power amount is maintained at a relatively high level, to ensure that the emergency loads can be used when the inverter disconnects from the grid. Its working logic is same with that of the self use mode.

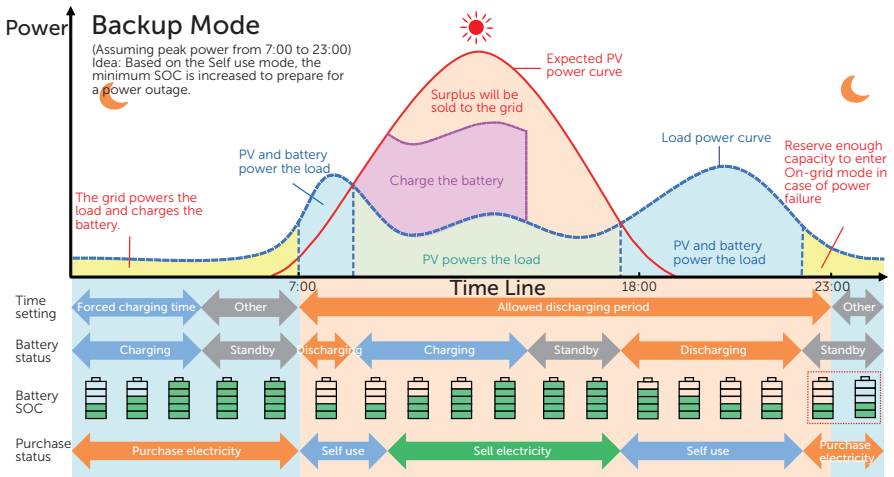

Figure 2-12 Backup mode

Table 2-6 Description of backup mode

Time period	Inverter working status
Forced charging period	Charge the battery first until the battery SOC reaches the specified value for Charge battery to . You can set whether the inverter draws power from the grid or not.

Time period	Inverter working status
Allowed discharging period	<p>Its working logic is basically the same as that in self use mode. The difference lies in:</p> <ul style="list-style-type: none">• In self use mode, the battery goes into hibernation when PV input is not available and the battery SOC reaches Min SOC (on-grid min SOC). In the event of a grid outage, the inverter will not enter EPS mode.• In backup mode, the inverter enters standby state when PV input is not available and the battery SOC reaches Min SOC (on-grid min SOC). In the event of a grid outage, it will switch to EPS mode until the battery discharges to Min SOC (Off-grid min SOC).

Note:

Min SOC (on-grid min SOC): Minimum SOC under grid connection. 30% by default, the settable range is 30%~100%.

Min SOC (off-grid min SOC): Minimum SOC under off-grid conditions. 10% by default, the settable range is 10%~100%.

NOTICE!

- You can set two working periods: forced charging period and allowed discharging period. Please refer to ["Charge & Discharge Period"](#) for details.
- If there is a foreseeable power outage, switch from other working modes to the backup mode in advance.

2.7.4 Peak Shaving Mode

Peak shaving mode is set for adjusting power consumption in peak hours. Through intelligent control, it is to ensure that the battery charges during off-peak hours and discharges during peak hours.

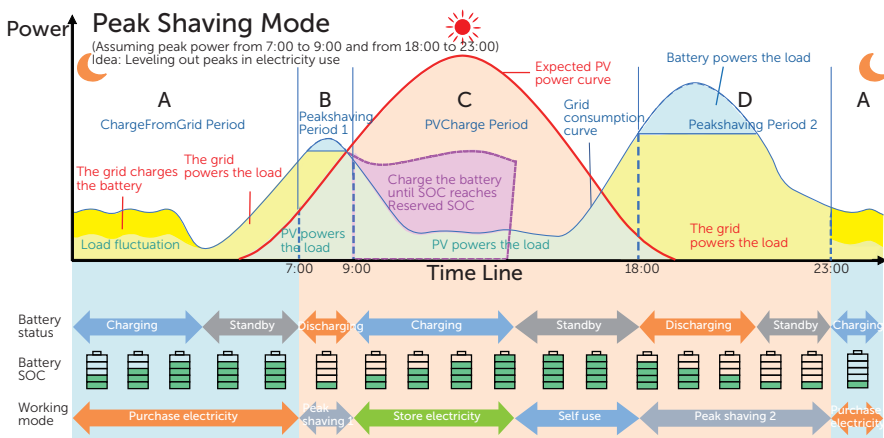

Figure 2-13 Peakshaving mode

Table 2-7 Description of peakshaving mode

Time Period	Inverter working status
Period A	The grid can charge the battery to MaxSOC within the set ChargePowerLimits . In this period, the battery will not discharge. Grid consumption power < PeakLimits (PV+grid → load) <ul style="list-style-type: none"> The PV and grid will both supply power to the load. The battery will not charge or discharge.
Period B & D	Grid consumption power > PeakLimits (PV + battery+grid → load) <ul style="list-style-type: none"> The battery will supply energy to loads, so as to reduce the amount of energy purchased from the grid.
Period C	(PV → battery → load → grid) <ul style="list-style-type: none"> The battery does not discharge. The PV charges the battery up to the Reserved SOC before supplying power to the loads. Any excess power beyond the load requirements is fed into the grid.

Note:

MaxSOC: The maximum amount of energy taken from grid to charge the battery. 50% by default, the settable range is 10%-100%.

ChargePowerLimits: The limit of power of taking power from grid. 1000 W by default, the

settable range is 0-60000 W.

PeakLimits: The limit of power of loads taking power from the grid side. 0 W by default, the settable range: 0-60000 W.

Reserved SOC: The lowest battery SOC set for a peak shaving period. 50% by default, the settable range is 10~100%.

2.7.5 TOU Mode

Different from the above four working modes, TOU mode only be set through the SolaXCloud (App or Web).

In TOU mode, you can set different working modes for different time slots according to the actual needs. One day can be divided into 10 time slots at most. Working modes available to each time slot include: Self use mode, Battery off, Peaking shaving mode, Charging mode, and Discharging mode. For details about how to set the TOU mode, refer to the guide document on the SolaXCloud (App or Web).

Table 2-8 Time slot setting

Time Slot	Working Mode
X:XX~X:XX	Choose one from Self use mode, Battery off, Peaking shaving mode, Charging mode, and Discharging mode.

Note:

Self use mode: Same working logic with "2.7.1 Self-use Mode", but it is not limited by the charging and discharging time slots. You need to set **Min SOC** for this mode.

Battery off: The battery neither charges nor discharges, except when the remaining battery energy is lower than the value of **Min SOC**, which is set at the beginning of creating a TOU.

Peak shaving mode: You need to set the value for **Peak Limit**. When the power consumption exceeds the value of **Peak Limit**, the battery and PV sides will both supply power to the loads, to ensure that the consumed power does not exceed the setting value.

Charging mode: If this mode is enabled, you need to further set the value for **Charge BAT to**.

Discharging mode: The battery discharges to a specified value. You need to set the values for **Rate of AC Power (%)** and **Discharge To**.

The setting items described above are based on the SolaXCloud V6.0.0, which may change with version upgrade. The final settings should be subject to the actual situations.

2.7.6 EPS Mode (Priority: Loads>Battery)

During power failure, the system will supply constant power to the EPS loads with the power from the PV and battery. It is important to ensure that the total power of EPS loads should not exceed the maximum output power of the battery.

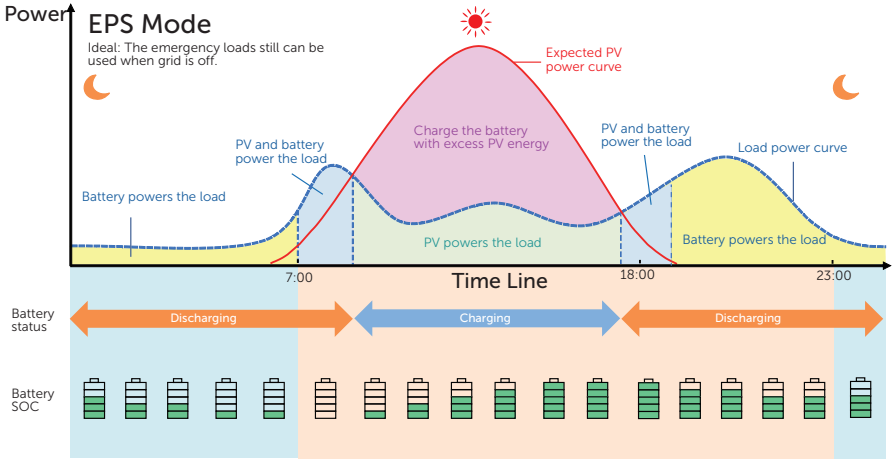

Figure 2-14 EPS mode

Table 2-9 Description of EPS mode

Battery SOC	Inverter working status
Battery SOC > Min SOC (off-grid)	<p>PV is sufficient (PV → load → battery)</p> <ul style="list-style-type: none"> The PV prioritizes supplying power to the load, with any excess energy being directed towards charging the battery.
Battery SOC ≤ Min SOC (off-grid)	<p>PV is insufficient (PV+battery → load)</p> <ul style="list-style-type: none"> The PV prioritizes supplying power to the load. If the energy is not enough, the battery will discharge power until the battery SOC reaches Min SOC. At this time, the error of BatPowerLow will be reported. <p>The inverter reports BatPowerLow. When there is PV input, it will charge the battery first until the battery reaches the Min ESC SOC value. At this time, the inverter will be automatically recovered and enter the EPS mode again.</p>

Note:

Min SOC: Minimum SOC of the battery when the inverter is in off-grid state. 10% by default, the settable range: 10%-100%.

Min ESC SOC: The minimum SOC required for re-entry EPS mode. 30% by default, the settable range: 15%-100%.

2.7.7 Manual Mode

Manual mode is only for the qualified debugging and maintenance personnel. It includes **Forced Discharge**, **Forced Charge** and **Stop Charging**. The mode will automatically exit after it has been working for 6 hours.

2.7.8 Export Control Function

Export control function is to control the amount of electricity exported from the PV to the grid. You need to set the export limit value (setting range: 0W ~ (exceed) rated output power) for the inverter. This inverter series has three-phase unbalanced output function. The following shows the export control function when the three-phase unbalanced is enabled and disabled:

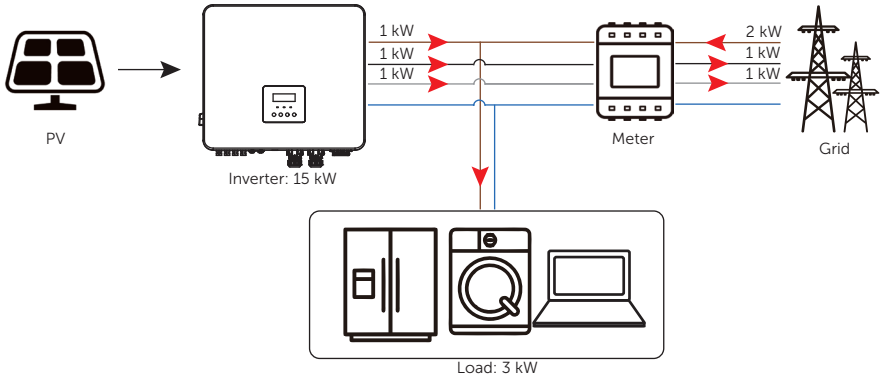

Figure 2-15 Zero export control with **Phase Unbalance** disabled

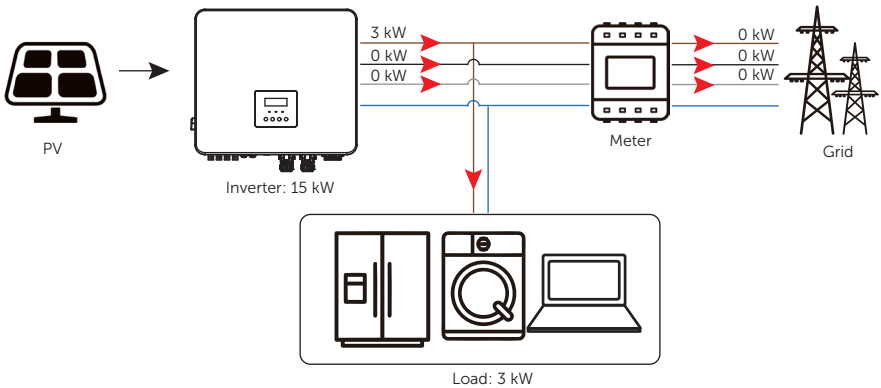

Figure 2-16 Zero export control with **Phase Unbalance** enabled

Note:

For details about setting the **Export Control** function, refer to “[Setting Export Control](#)”.

3 System Overview

System Overview

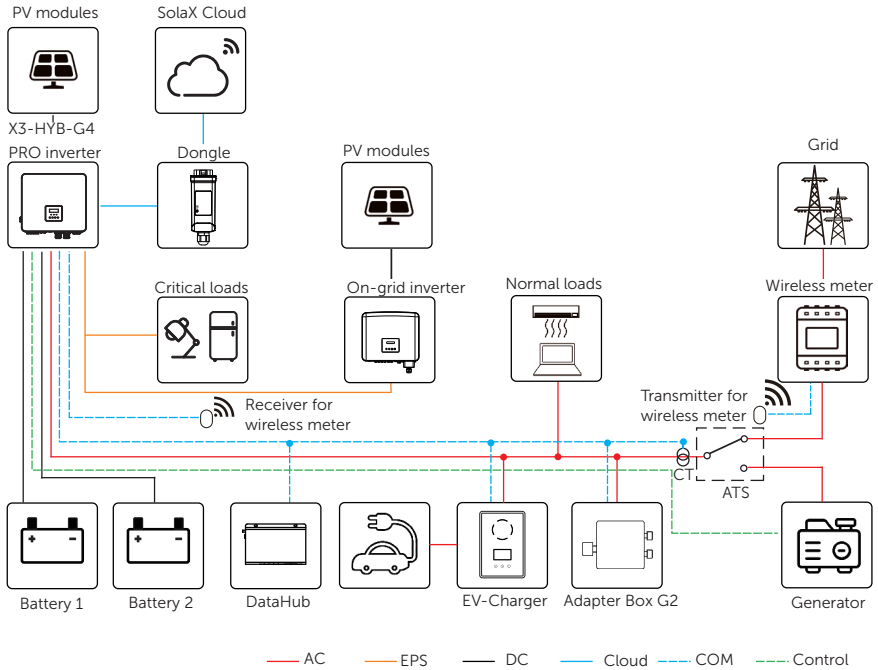

Figure 3-1 System diagram

NOTICE!

- The above diagram is only for reference. In practice, some devices cannot be used together. For example, if an on-grid inverter and a generator are connected to the X3-HYB-G4 PRO inverter simultaneously, the system will crash.

Table 3-1 System item description

Item	Description
X3-HYB-G4 PRO series (the device models covered by this manual)	The X3-HYB-G4 PRO series is an energy storage inverter that supports grid connection of a photovoltaic system.
PV modules	PV modules work in MPPT mode. For 4 kW, 5 kW, and 6 kW inverters, the maximum number of MPPTs is 2. For 8 kW, 10kW, 12 kW, and 15 kW inverters, the maximum number of MPPTs is 3.
Battery	The series inverter should be coupled with the lithium-ion battery. Two battery ports can be conencted with two battery clusters. It communicates with the inverter via the BMS port and must comply with the specifications of the regulations.
Meter/CT	By reading the meter or CT data, the inverter can control the battery to charge or discharge, so as to achieve intelligent energy management. Besides, the inverter supports the wireless meter solution.
Additional on-grid inverter (supported)	The series inverter supports micro-grid function. By connecting another inverter to the EPS port of the current inverter, the current inverter plays as the grid to supply power to another inverter during the off-grid period. Please refer to "15.5 Application of Micro-grid" for specific wiring and setting.
Adapter Box G2 (supported)	With a SolaX Adapter Box G2, you can connect a smart heat pump to the energy storage system, so as to control the heat pump through an inverter. Please refer to "15.2 Application of Adapter Box G2" for specific wiring and setting.
DataHub (supported)	SolaX DataHub is a professional device for data collection and storage, export control, integrated monitoring, and integrated maintenance. It serves the inverter, meter, environment monitoring equipment in the photovoltaic system. Please refer to "15.4 Application of DataHub" for specific wiring and setting.
EV-Charger (supported)	The series inverter can communicate with SolaX EV-Charger to form an intelligent photovoltaic, storage and EV charging energy system, thus maximizing the utilization of photovoltaic energy. Please refer to "15.3 Application of EV-Charger" for specific wiring and setting.
Generator (supported)	The generator solution offers a stable and reliable power supply, and meanwhile lowers energy costs. Please refer to "15.1 Application of Generator" for specific wiring and setting.

Item	Description
Grid	400 V / 230 V and 380 V / 220 V grid are supported.
SolaX Cloud	SolaX Cloud is an intelligent, multifunctional monitoring platform that can be accessed in a wired or wireless way. With the SolaX Cloud, operators and installers can view important and up-to-date data at any time.

4 Transportation and Storage

If the inverter is not put into use immediately, the transportation and storage requirements need to be met:

Transportation

- Observe the caution signs on the packaging of inverter before transportation.
- Pay attention to the weight of the inverter. Carry the inverters by the required number of personnel as specified by local regulations.(gross weight of X3-HYB-G4 PRO: 45 kg)
- Wear protective gloves and safety shoes when carrying the equipment to prevent injuries.
- When lifting up the inverter, hold the handle and bottom of the carton. Keep the inverter horizontal in case of falling down.

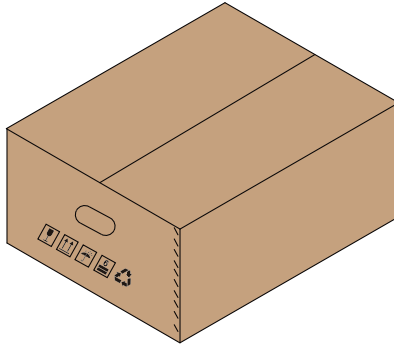

Figure 4-1 Caution signs on the packaging

Storage

- The inverter must be stored indoors.
- Do not remove the original packaging material and check the outer packaging material regularly.
- The storage temperature should be between -40°C and $+65^{\circ}\text{C}$. The relative humidity should be between 35% and 70%.
- Stack inverters in accordance with the caution signs on the inverter carton to prevent device damage caused by falling down. Do not place it upside down.

5 Preparation before Installation

5.1 Selection of Installation Location

A good installation location is critical to the safety, service life and performance of the inverter. This inverter has the IP66 ingress protection, so it can be installed outdoor. Besides, the installation location should be selected for convenience of wire connection, operation and maintenance.

5.1.1 Environment Requirement

- Ambient temperature: -35°C to $+60^{\circ}\text{C}$.
- Relative humidity: 0 to 100% (condensing).
- Do not install the inverter in the areas where the altitude exceeds 3000 m.
- Install the inverter in a well-ventilated environment for heat dissipation. It is recommended to install an awning over the inverter if it is installed on an outdoor support.
- Do not install the inverter in areas with flammable, explosive and corrosive materials or near antennas.
- Avoid direct sunlight, rain exposure and snow accumulation.

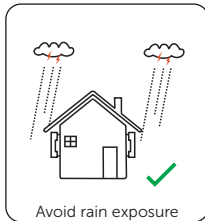
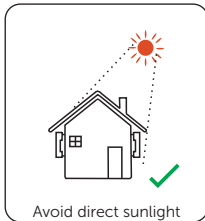
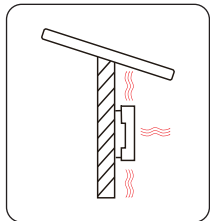
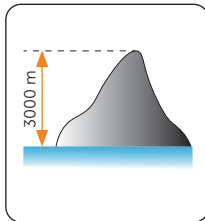
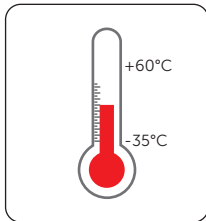

NOTICE!

- For outdoor installation, precautions against direct sunlight, rain exposure and snow accumulation are recommended.
- Exposure to direct sunlight raises the temperature inside the device. This temperature rise poses no safety risks, but may impact the device performance.

- Install the inverter at least 500 meters away from the coast and avoid direct blowing and hitting of sea breeze.

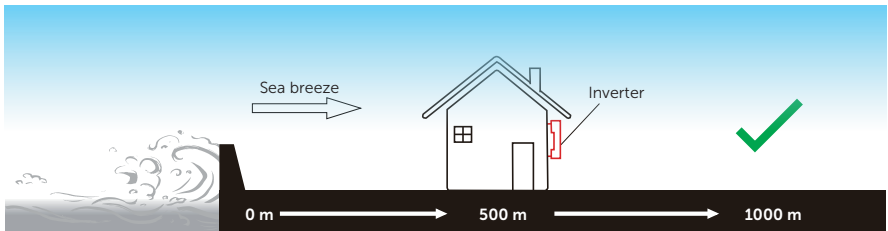

Figure 5-1 Recommended installation position

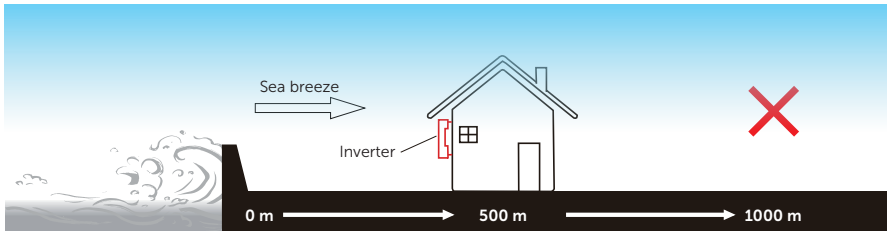

Figure 5-2 Incorrect installation position

NOTICE!

- For installation of the whole system, please refer to the specific environment requirement of each unit.

5.2 Installation Carrier Requirement

The installation carrier must be made of a non-flammable material, such as solid brick, concrete. It should be capable of supporting the weight of the inverter and suitable for the dimensions of the inverter. If the load-bearing capacity of a wall is not high (such as wooden wall and wall covered by a thick layer of decoration), it must be improved accordingly.

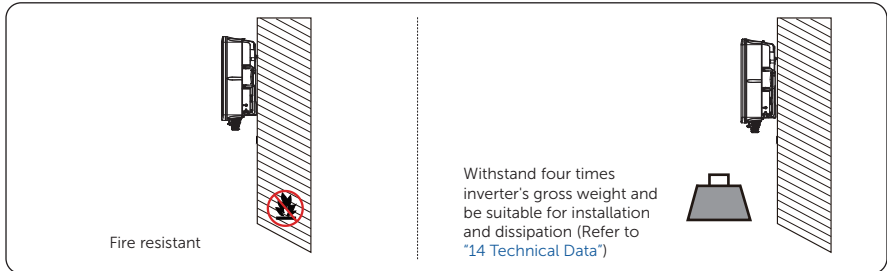

Figure 5-3 Installation carrier requirement

NOTICE!

- Please take the weight of battery into account when installing the whole system onto the wall.

5.2.1 Clearance Requirement

The minimum clearance reserved for connecting wires to ports at the bottom of inverter should be 13.5 cm. You also should take the bending radius of the wires into consideration.

Besides, to guarantee proper heat dissipation and ease of disassembly, the minimum space around the inverter must meet the requirements below:

- For installation of a single inverter: The bottom must be at least 50 cm away from the ground. Its Above, Left, Right, and Front must keep a minimum distance of 30 cm with other objects.
- For installation of multiple inverters: The interval between two inverters should be at least 30 cm transversely and 100 cm longitudinally. In addition, the row of inverters at the bottom should be at least 50 cm above the ground. In areas with high ambient temperatures, increase the spacing between inverters appropriately, to maintain good ventilation.

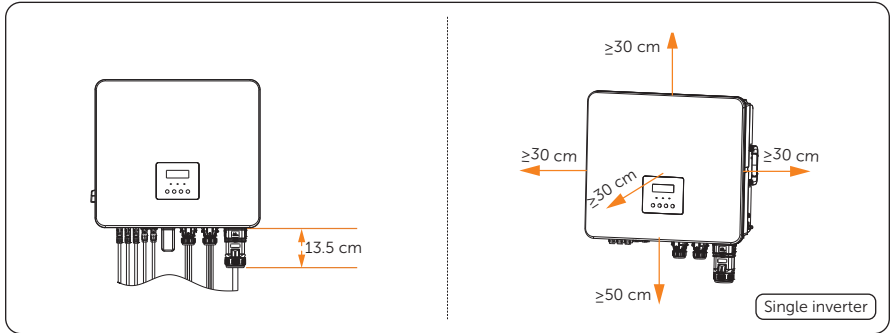

Figure 5-4 Clearance requirement for single inverter

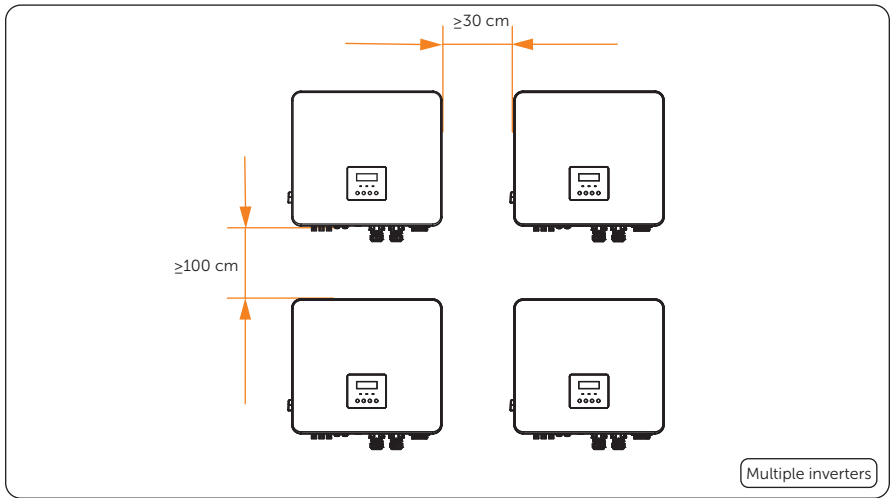

Figure 5-5 Clearance requirement for multiple inverters





5.3 Tools Requirement

Installation tools include but are not limited to the following recommended ones. If necessary, use other auxiliary tools on site. Please note that the tools used must comply with the local regulations.

 Hammer drill (drill bit: Ø10 mm)	 Multimeter (> 1100 V DC)	 Measuring tape	 Utility knife
 Marker	 Torque screwdriver (Flat-head: M2) (Phillips head: M2.5 / M3 / M5)	 Spirit level	 Allen key (including M5 wrench)
 Wire stripper	 Crimping tool for RJ45 terminal	 Crimping tool for PV terminals	 Diagonal pliers
 Crimping tool	 Crimping tool for ferrules	 Wire cutter	 Rubber mallet
 Torque wrench	 Heat gun	 Heat shrink tubing (Ø6 mm)	 15 mm open-end wrench
 Safety gloves	 Safety boots	 Safety goggles	 Anti-dust mask

5.4 Additionally Required Materials

Table 5-1 Additionally required wires

No.	Required Material	Type	Conductor Cross-section
1	PV cable	 Dedicated PV cable with a voltage rating of 1000 V, a temperature resistance of 105°C, a fire resistance grade of VW-1	4 mm ²
2	Communication cable	 Network cable CAT5E	/
3	PE cable	 Conventional yellow and green cable	6 mm ²
4	Battery cable (if required)	 UL cable	6 mm ²

NOTICE!

- For users who purchased the X3-Matebox G2, there is no need to prepare the battery wire because it has been included in the accessory pack. For specific installation steps, please refer to *X3-Matebox G2 Series Installation Manual*.

Table 5-2 Cable and circuit breaker recommended for Grid-side connection



Model	4 kW	5 kW	6 kW	8 kW	10 kW	12 kW	15 kW
Five-core copper cable 	4-6 mm ²	4-6 mm ²	4-6 mm ²	4-6 mm ²	6 mm ²	6 mm ²	6 mm ²
Circuit breaker 	20 A	20 A	20 A	32 A	40 A	40 A	40 A

Table 5-3 Cable and circuit breaker recommended for EPS-side connection

Model	4kW	5kW	6kW	8kW	10kW	12kW	15kW
Five-core copper cable 	4-6 mm ²	4-6 mm ²	4-6 mm ²	4-6 mm ²	6 mm ²	6 mm ²	6 mm ²

Model	4kW	5kW	6kW	8kW	10kW	12kW	15kW
Breaker 	16 A	16 A	16 A	20 A	25 A	32 A	32 A

NOTICE!

- For users who purchased the X3-Matebox G2, there is no need to prepare the battery wire because it has been included in the accessory pack. For specific installation steps, please refer to *X3-Matebox G2 Series Installation Manual*.

6 Unpacking and Inspection

6.1 Unpacking

- The inverter undergoes 100% testing and inspection before delivery. However, damages may still occur during transportation. Before unpacking, please carefully check the external packaging for any signs of damage, such as punctures or cracks.
- Unpacking the inverter according to the following figure.

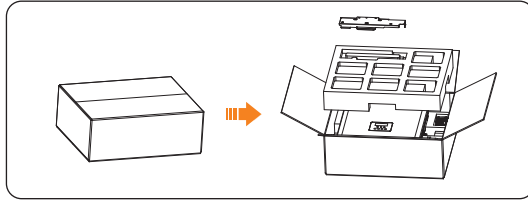

Figure 6-1 Unpacking the inverter

- Properly handle all the packaging materials in case they may be reused for storage and transportation of the inverter in the future.
- Upon opening the package, check whether the inverter is intact and whether all accessories are included. If any damage is found or any parts are missing, contact your dealer immediately.

6.2 Scope of Delivery











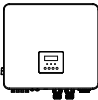
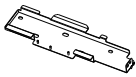









 Inverter	 Bracket	 Positioning cardboard	 Positive PV pin contact Positive PV connector
 Negative PV pin contact Negative PV connector	 Positive battery connectors	 Negative battery connectors	 AC connector Disassembly tool Allen key
 Expansion tubes	 Self-tapping screws	 M5 screw	 6 mm ² AC ferrules
 4 mm ² AC ferrules	 RJ45 terminals RJ45 connector	 OT terminal	 Disassembly tool for PV connector
 CT (Optional)	 Positive PV dustproof buckles Negative PV dustproof buckles	 Wire shielding cover (Only for Australia&New Zealand)	 Bracket for wire shielding cover (Only for Australia&New Zealand)
 M4 screw (Only for Australia&New Zealand)	 Document	 Dongle	

Table 6-1 Packing list

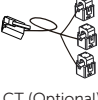
Item	Description	Quantity	Remarks
/	Inverter	1 pc	

Unpacking and Inspection

Item	Description	Quantity	Remarks
A	Bracket	1 pc	
B	Positioning cardboard	1 pc	
C	Positive PV pin contact	<ul style="list-style-type: none"> • 2 pcs for 4 kW, 5 kW, and 6 kW inverters • 3 pcs for 8 kW, 10 kW, 12 kW, and 15 kW inverters 	Used for connecting to the PV port.
D	Positive PV connector		
E	Negative PV pin contact		
F	Negative PV connector		
G	Positive battery connectors	2 pcs	Used for connecting to the battery port.
H	Negative battery connectors	2 pcs	
I	AC connector	1 pc	
J	Disassembly tool	1 pc	
K	Allen key	1 pc	Used for tightening the screw on the AC connector.
L	Expansion tubes	5 pcs	Used to fix the bracket.
M	Self-tapping screws	5 pcs	Used to fix the bracket.
N	M5 screw	1 pc	Used to fix the inverter.
O	6 mm ² AC ferrule	10 pcs	Used for wiring to Port Grid&EPS. It's suitable for all inverter models in this series.
P	4 mm ² AC ferrule*	10 pcs	Used for wiring to Port Grid&EPS. It's only suitable for 4 kW, 5 kW, 6 kW, and 8 kW inverters.
Q	RJ45 terminals	12 pcs	Used for connecting to subports of ports COM1 and COM2.
R	RJ45 connector	1 pc	Used for connecting a CT.
S	OT terminal	2 pcs	Used for connecting the ground wire to the inverter.
T	Disassembly tool for PV connector	1 pc	

Item	Description	Quantity	Remarks
U	CT (Optional)	1 pc	<ul style="list-style-type: none"> For inverters equipped with CT, the label on the packing box is marked with "CT". For inverters equipped with meter, the label on the packing box is marked with nothing.
V	Positive PV dustproof buckles	3 pcs	
W	Negative PV dustproof buckles	3 pcs	
X	Wire shielding cover	1 pc	Only sold to Australia and New Zealand. Used to protect the PV and battery power cables.
Y	Bracket for wire shielding cover	1 pc	Only sold to Australia and New Zealand. Used to support the wire shielding cover.
Z	M4 screw	6 pcs	Only sold to Australia and New Zealand. Used to fasten the wire shielding cover and bracket.
A1	Document	/	
/	Dongle	1 pc	Used for communication between this inverter and the SolaXCloud.

NOTICE!

- The optional accessories are subject to the actual delivery.
- "*": For a 4.0, 5.0, 6.0, or 8.0 kW inverter, we offer you two choices: 6 mm² AC ferrules and 4 mm² AC ferrules. Please select one according to the diameter of the Grid or EPS cable.

7 Mechanical Installation

WARNING!

- Only qualified personnel are allowed to perform the mechanical installation in accordance with local laws and regulations.
- Check the existing power cables or other piping in the wall to prevent electric shock or other damage.
- Use insulated tools and wear personal protective equipment throughout the installation and maintenance process.

CAUTION!

- During installation, always be cautious about the weight of the inverter. Improper lifting or dropping of the inverter may result in personal injury.

NOTICE!

- Install the inverter at a maximum back tilt of 5 degrees and avoid it being forward tilted, side tilted, or upside down.

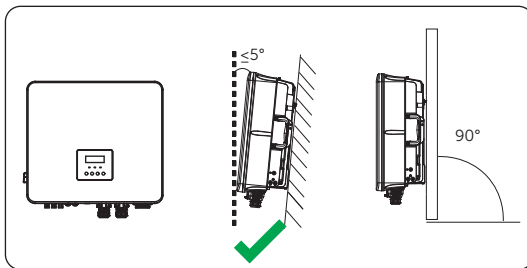

Figure 7-1 Correct installation

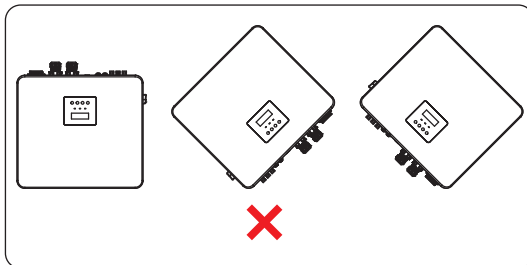

Figure 7-2 Incorrect installation

7.1 Dimensions for mounting

The size of the positioning cardboard is consistent with that of the inverter. Before installation, put the positioning cardboard onto the wall, to measure whether the current space is suitable for the dimensions of the inverter and reserve enough installation and heat dissipation space.

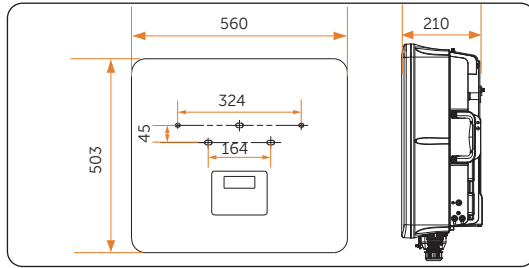

Figure 7-3 Dimensions (Unit: mm)

7.2 Installation procedures

According to Australian regulations, a wire shielding cover must be installed, to protect the PV dedicated cables and battery power cables. However, there is no such regulations in other countries and regions. The following provides the whole procedure for installing a wire shielding and an inverter.

Users should select proper steps according to your country or region:

- For users in Australia and New Zealand, follow all the steps below.
- For users in other countries and regions, follow steps 2 to 7.

Step 1: Take out the inverter and put it down with its back upwards. Take the bracket (part Y) from the accessory bag with its back upwards. Attach the bracket to the lower right corner of the inverter, to align the preserved screw holes. Put screws (part Z) into holes and tighten them one by one with a screwdriver.

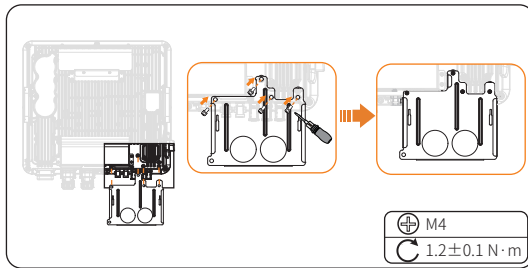

Figure 7-1 Installing the bracket

NOTICE!

- When placing the inverter onto the ground, cushion its bottom with foam or other protective materials, avoid damage to the inverter.
- Prevent ports of the device from directly colliding with the ground or other objects, to reduce damage to the ports.

Step 2: Attach the positioning cardboard (part B) to the surface of the wall. Use a spirit level to make the cardboard horizontal. Draw circles on the wall as markers when threading a marking pen through holes of the cardboard sequentially. If all done, take the cardboard from the wall.

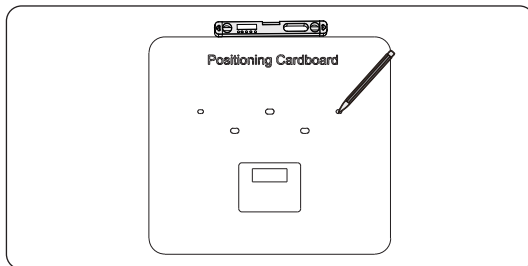

Figure 7-2 Marking the holes

NOTICE!

- Not equipped with battery: The bottom of the cardboard should be at least 50 cm above the ground. A distance of more than 140 cm is preferred for a single inverter.
- Equipped with battery: Reserve the enough space for batteries. For dimensions of batteries, refer to the corresponding battery manual.

Step 3: Aim the hammer drill (bit: Ø10 mm) at the center of the markers and drill 5 holes

with a depth of not less than 60 mm. Insert 5 expansion tubes (part L) into the holes sequentially.

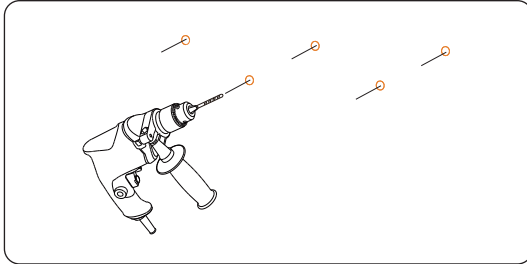

Figure 7-3 Drilling holes

Step 4: Attach the bracket (part A) to the wall. Insert self-tapping screws (part M) into the expansion tubes. If necessary, knock them into the holes with a rubber mallet. Tighten the screws with a torque wrench (size: 10 mm).

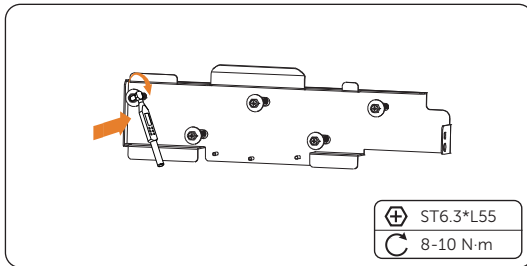

Figure 7-4 Securing the bracket

Step 5: Pull out the handles on both sides of the inverter. Lift up the inverter collaboratively by the number of personnel in accordance with the local regulation and hang it onto the bracket. Make sure that the keyway on the back of the inverter is accurately put into the hooking groove of the bracket. If placed correctly, the leftmost side of the device will be next to the left inner side of the bracket (the location shown in Figure 7-6).

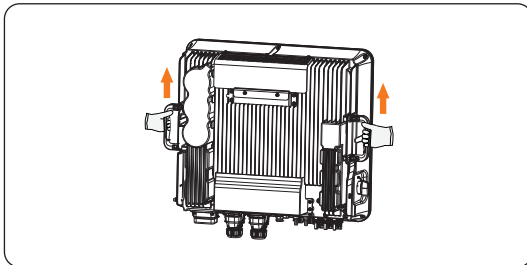

Figure 7-5 Pulling out the handles and lifting the device up

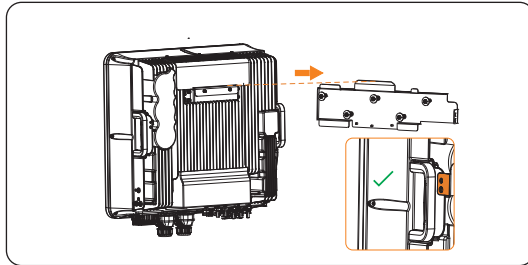

Figure 7-6 Hanging the device onto the bracket

NOTICE!

- If the inverter needs to be placed onto the ground temporarily, use foam or other protective materials to cushion its bottom to avoid damage to the inverter.
- Prevent ports of the device from directly colliding with the ground or other objects, to reduce damage to the ports.

Step 6: Use a M5 screw (part N) to secure the inverter.

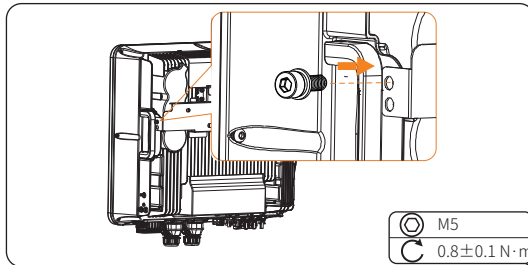

Figure 7-7 Securing the inverter

Step 7: (Optional) Install an anti-theft lock. The anti-theft lock is not in the scope of delivery. If necessary, prepare a lock with a diameter $\varnothing 5$ mm by yourself, and keep the key to the lock properly.

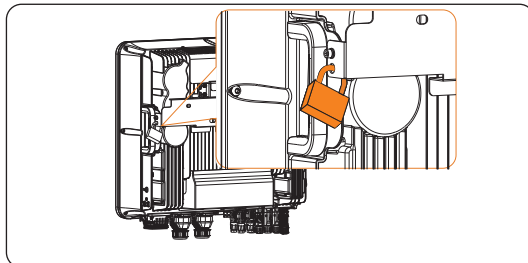

Figure 7-8 Locking the inverter

Step 8: Cut the wire protection ring along the cross-shaped dent with a utility knife.

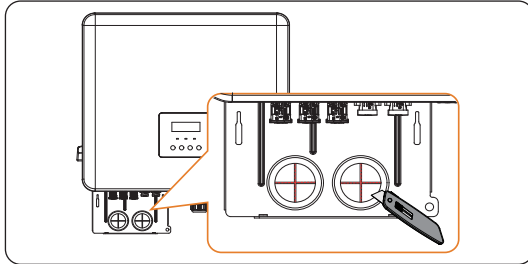

Figure 7-9 Cutting the wire protection ring

Step 9: Handle the PV cables and battery power cables according to steps 1 to 6 in “8.4 PV Connection” and steps 1 to 4 in “8.5 Battery Power Cable Connection”, respectively. Put two types of cables together and sort them into two bundles by polarity. As shown in this figure, thread the two bundles through two holes of the bracket separately. Connect the PV cables and battery power cables to the PV and battery ports respectively according to steps 7 and 8 in “8.4 PV Connection” and step 5 in “8.5 Battery Power Cable Connection”.

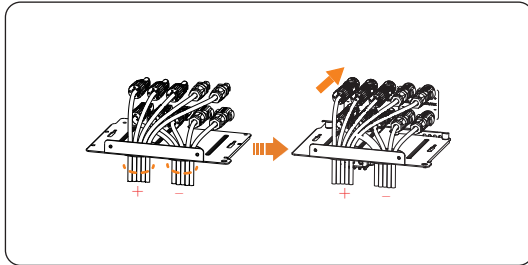

Figure 7-10 Sorting and threading cables

Step 10: Take a wire shielding cover (part X) out from the accessory bag. Put the hook of the cover into the hole on the bracket, and then support the cover with one hand. Secure the cover with two screws.

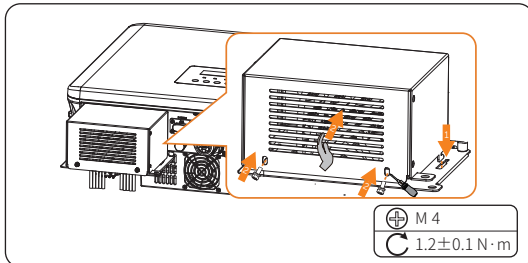

Figure 7-11 Securing the wire shielding cover

Step 11: (Optional) If necessary, lock the wire shielding cover with a $\varnothing 5$ mm lock. The lock is not in the scope of delivery, so please prepare it by yourself.

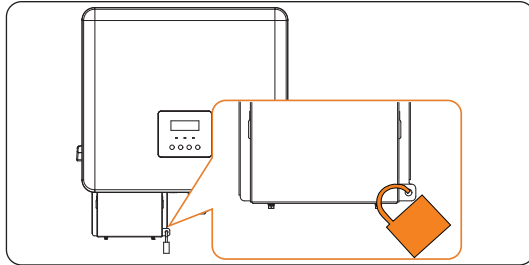

Figure 7-12 Locking the wire shielding cover

8 Electrical Connection

DANGER!

- Before electrical connection, make sure the DC switch and AC breaker are disconnected. Otherwise, the high voltage may cause electric shock, resulting in severe personal injuries or even death.

WARNING!

- Only qualified personnel are allowed to perform the electrical connection according to the local laws and regulations.
- Strictly follow the instructions of this manual or other related documentation for electrical connection. Inverter damages caused by incorrect wiring are not covered by the warranty.
- Use insulated tools and wear personal protective equipment throughout the electrical connection process.

8.1 Overview of Electrical Connection

8.1.1 Ports and Parts of Inverter

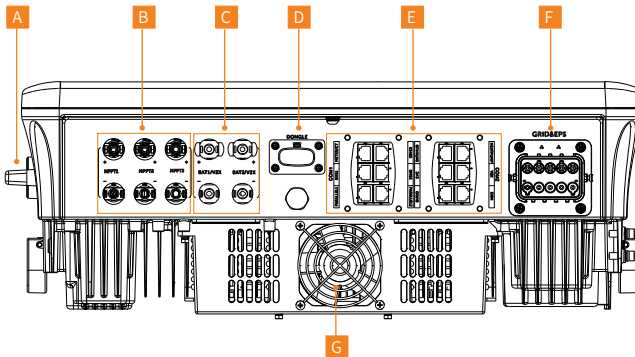

Figure 8-1 Ports and parts of Inverter

Table 8-1 Description of ports and parts

Item	Description	Remarks
A	DC switch	
B	MPPT ports	For inverters 4 kW, 5kW, and 6kW, MPPT1 and MPPT2 are available. For inverters 8kW, 10kW, 12kW, and 15kW, MPPT1, MPPT2, and MPPT3 are available.
C	BAT/V2X ports	The battery port and V2X (Vehicle to X) port are combined into one. Each battery port can connect with a battery cluster. The models of the two battery clusters may be different but battery modules in each battery cluster must be of the same model. Port V2X can be connected with a V2X module.
D	Port for a monitoring module Dongle Pocket	Through this port, the dongle pocket can establish a connection with the inverter and upload the data to the SolaX Cloud.
E	Communication port COM 1	Includes subports Parallel 1, Parallel 2, BMS 1, BMS 2, RS485, and Meter/CT.
	Communication port COM 2	Includes subports DI/DO, EVC, DATAHUB, DRM, V2X, and Heatpump.
F	Grid & EPS port	
G	Fan	

8.1.2 Cable Connections of Inverter

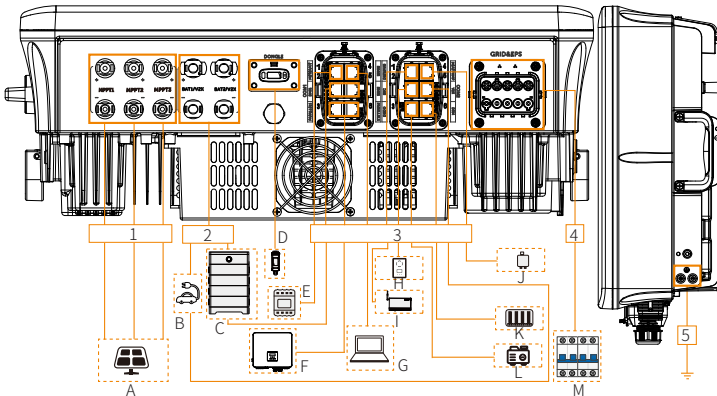

Figure 8-2 Cable connections of inverter

Table 8-2 Description of connected part

Item	Part	Description	Source
A	PV module	A PV string is formed of PV modules connected in string. The number of PV modules in a string varies with the model.	Prepared by user
B	V2X module	It connects to a new energy electric vehicle, to manage charging and discharging of the in-vehicle battery.	Purchased from SolaX
C	Battery	Support battery models T-BAT-SYS-HV-S25, T-BAT-SYS-HV-S36, T-BAT-SYS-HV-3.0, T-BAT-SYS-HV-S50E-D, T-BAT-SYS-HV-S51, and T-BAT-SYS-HV-5.8.	Purchased from SolaX
D	(Optional) monitoring module	Only support the SolaX energy monitoring module.	Purchased from SolaX
E	Meter/CT	Support the meter and CT authorized by SolaX: DTSU666 and DTSU666-CT.	Purchased from SolaX
F	(Optional) X3-HYB-G4 PRO series inverter	Select an inverter of the same power range.	Purchased from SolaX
G	External device	All external devices that support the Modbus protocol, for example computer.	Prepared by user

Electrical Connection

Item	Part	Description	Source
H	EV charger	Support SolaX EV charger.	Purchased from SolaX
I	Datahub	Support SolaX DataHub.	Purchased from SolaX
J	AdapBox	Support SolaX AdapBox G2.	Purchased from SolaX
K	Power grid management equipment (only used in Australia and Newzealand)	Select the devices that meet the power grid management requirements.	Prepared by user
L	(Optional) Device controlled through dry contact	Support generator and system switch. <ul style="list-style-type: none"> For generator, select a generator equipped with an ATSE (Automatic Transfer Switching Equipment), and make sure that "Load power + Battery charging power < Rated output power of the generator". For system switch, select a self-locking switch. 	Prepared by user
M	AC circuit breaker	Select an appropriate AC switch according to the local regulations, to ensure the inverter can be securely disconnected from the grid when an emergency occurs. Refer to "5.4 Additionally Required Materials" for the recommended specifications of AC switch.	Prepared by user

Table 8-3 Descriptions of cables

Item	Cable	Type and specifications	Source
1	PV cable	Refer to "5.4 Additionally Required Materials".	Prepared by user
2	Battery power cable		Prepared by user, except that you have purchased the X3-Matebox G2
3	Communication cable		Prepared by user
4	Grid & EPS cable		Prepared by user
5	PE cable		Prepared by user

8.2 PE Connection

The inverter must be reliably grounded. The PE connection point has been marked with



It is recommended to connect the inverter to a nearby grounding point.

PE connection procedures

Step 1: Strip the insulation of the PE cable to an appropriate length.

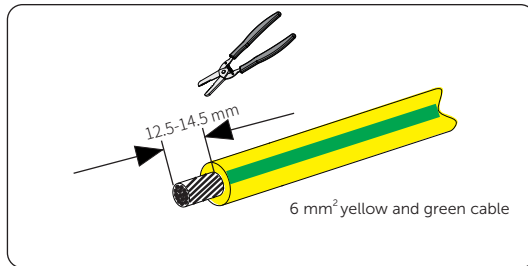

Figure 8-3 Stripping the PE cable

Step 2: Strip a heat-shrink tubing with a length of 28-30 mm. Thread the the PE cable through the heat-shrink tubing until it passed the stripped section, and then insert the stripped section into the OT terminal (part S).

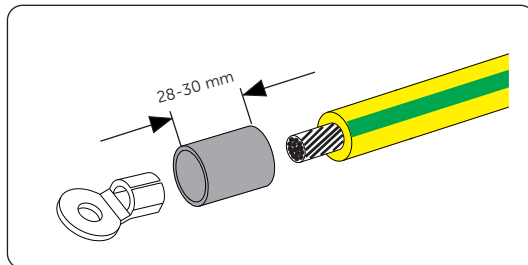

Figure 8-4 Installing the tubing and OT terminal

Step 3: Crimp the stripped section and the OT terminal together with a crimping tool. Move the heat-shrink tubing, to make it surround the crimping area. Heat the heat-shrink tubing, so that it can be firmly attached to the terminal.

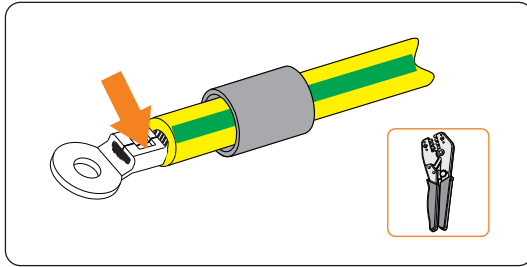

Figure 8-5 Crimping the cable

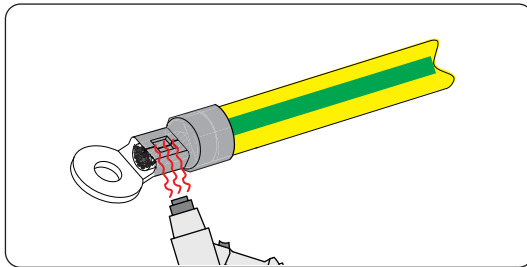

Figure 8-6 Shrinking the tubing

Step 4: Remove the PE screw from the inverter with an Allen key.

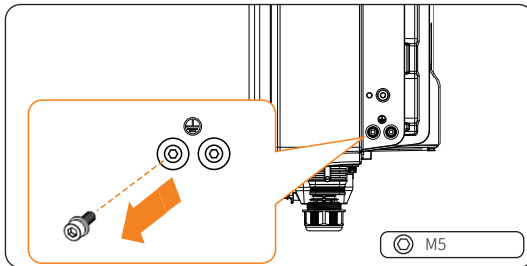

Figure 8-7 Uninstalling the screw

NOTICE!

- This inverter has two PE connection points. You can choose either of them.

Step 5: Connect the assembled PE cable to the PE connection point of the inverter, and secure it with the original screw.

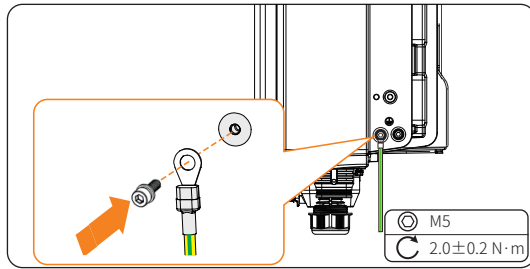

Figure 8-8 Securing the PE cable

8.3 AC Connection

NOTICE!
<ul style="list-style-type: none">• According to the national and state interconnection regulations, you must be approved by the local utility before connecting the inverter to the grid.

The inverter supports the EPS mode. When connected to the grid, the output of the inverter goes through the Grid port, and when disconnected from the grid, the output of the inverter goes through the EPS port.

Requirements for AC connection

- Grid voltage requirement
 - » The grid voltage and frequency must be within the allowable range (400 V / 230 V, 380 V / 220V, 50 / 60 Hz) and comply with the requirements of the local power grid.
- Residual Current Device (RCD)
 - » The inverter does not require an external RCD during running. If an external RCD is required by local regulations, a 300-mA Type-A RCD is recommended. If required by local regulations, a Type-B RCD is also permitted.
- AC breaker
 - » An AC breaker that matches the power of the inverter must be used between the inverter output end and the power grid. Each inverter must be equipped with an independent breaker or other load disconnection unit, to ensure a safe disconnection from the grid. For specific information on the AC breaker for Grid and EPS, refer to ["5.4 Additionally Required Materials"](#).
- EPS load
 - » Make sure the rated power of the EPS load is within the rated output power range of the inverter. Otherwise, the inverter will report an alarm of **EPS Overload Fault**. In this case, turn off some loads to make the power fall within the rated EPS output power range, and then press the **ESC** key on the LCD screen to clear the fault.
 - » When connecting to the EPS port, pay attention to the following points:

Medical equipment	Connection prohibited
Precision instrument	Connection prohibited
Appliances susceptible to malfunctions due to power outages	Connection prohibited
 - » For inductive loads such as refrigerators and air conditioner, ensure that their start power does not exceed the EPS peak power of the inverter.

Table 8-4 EPS load information

Type of load	Equipment	Start power
Resistive load	Lamp	Rated power
	Fan	3-5 times rated power
	Hair dryer	3-5 times rated power
Inductive load	Refrigerator	3-5 times rated power
	Air conditioner	3-6 times rated power
	Washing machine	3-5 times rated power
	Microwave oven	3-5 times rated power

*The actual start power of equipment is subject to the actual nominal start power.

Wiring procedures

NOTICE!

- Here take connecting to Grid and EPS sides as an example, to show you how to connect Grid and EPS cables to the Grid and EPS sides at the same time. In actual situations, users can only connect to the Grid side. Please make corresponding adjustments according to the actual situations.

Step 1: Prepare two five-core cable as Grid and EPS cables. Strip the insulations of conductors L1, L2, L3, N and PE to an appropriate length.

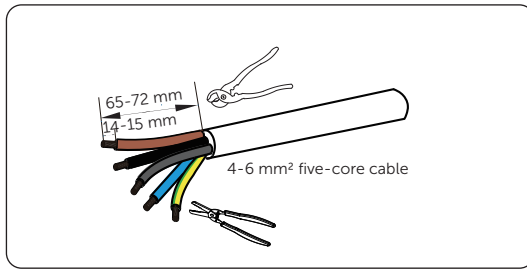

Figure 8-9 Stripping the Grid and EPS cables

NOTICE!

- The five-core cable with the diameter of 4-6 mm² is only taken as an example. Please select the proper cable diameter according to the power of your inverter.

Step 2: Insert conductor L1, L2, L3, N and PE of the Grid and EPS cables into ferrules (part O or P) separately. Crimp each ferrule and conductor together with a crimping tool. Make sure the conductors are correctly assigned and firmly seated in the ferrules.

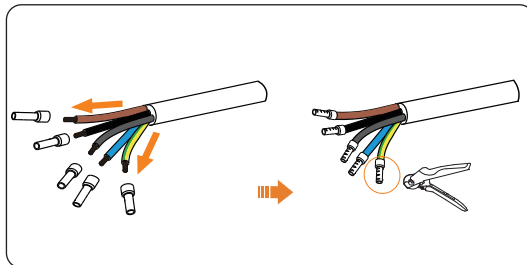

Figure 8-10 Crimping core and ferrule together

Step 3: Take out the AC connector (part I) from the accessory pack. Disassemble the AC connector.

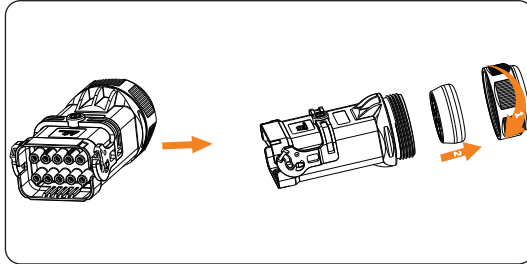

Figure 8-11 Disassembling the AC connector

» Cut the innermost round membrane with a utility knife.

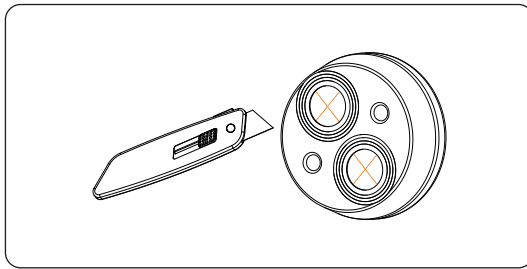

Figure 8-12 Cutting the round membrane

NOTICE!

- If only one round hole is needed, please do not cut the other round membrane, to ensure the sealing of the inverter.

» According to the outside diameters of the cable, take out the corresponding sealing plug with your hand.

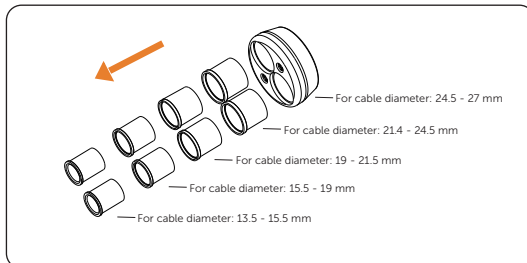

Figure 8-13 Taking out sealing plug

- » Insert the disassembly tool (part J) for the rubber core into the AC connector. Press the disassembly tool with one hand, and meanwhile poke the rubber core from the other end of the AC connector with a screwdriver held by the other hand, until the rubber core is poked out of the enclosure of the AC connector.

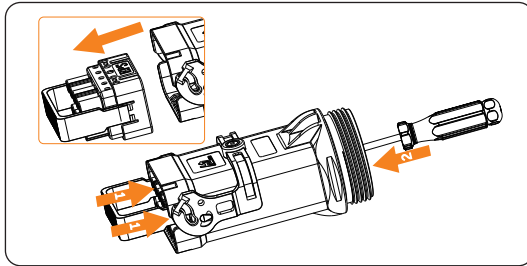

Figure 8-14 Poking the rubber core out

- Step 4:** Thread the Grid and EPS cables through the swivel nut, cable support sleeve, and the enclosure separately. Insert the crimped conductors L1, L2, L3, N, and PE into the corresponding position of the rubber core and tighten them.

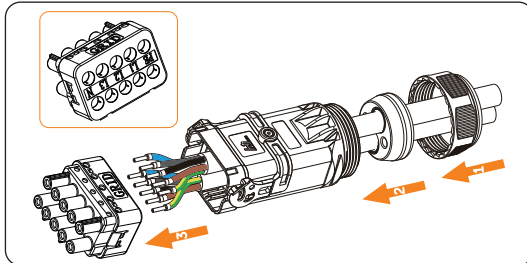

Figure 8-15 Threading and tightening conductors

- » For Grid: Insert Conductor L1 of the Grid cable into Position L1 of the Grid side of the rubber core. Observe whether the conductor is in the right place through the hole of the rubber core. If yes, tighten the screw with the Allen key (part K). Connect L2, L3, N, and PE in the same way.

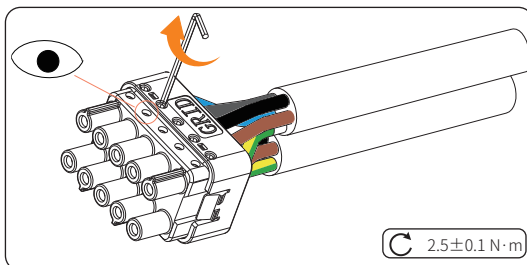

Figure 8-16 Inserting the Grid cable into the rubber core and tightening

- » For EPS: Insert Conductor L1 of the EPS cable into the L1 position of the EPS side of the rubber core. Observe whether the conductor is in the right place through the hole of the rubber core. If yes, tighten the screw with the Allen key (part K). Connect L2, L3, N, and PE in the same way.

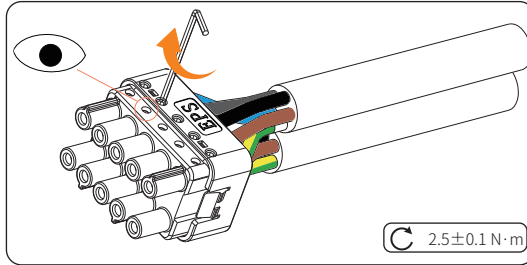

Figure 8-17 Inserting the EPS cable into the rubber core and tightening

- Step 5:** Put the rubber core and cable support sleeve back to the AC connector enclosure, and tighten the swivel nut.

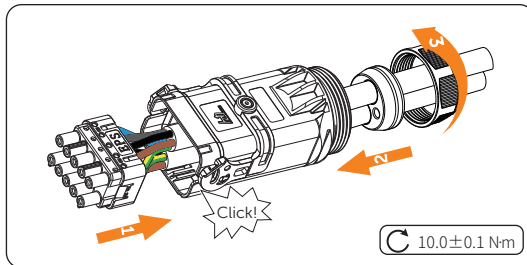

Figure 8-18 Assembling the AC connector

- Step 6:** Remove the cap from the Grid & EPS port. Pull the latch on the AC connector up.

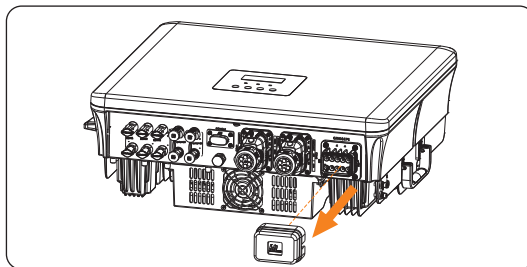

Figure 8-19 Removing the cap

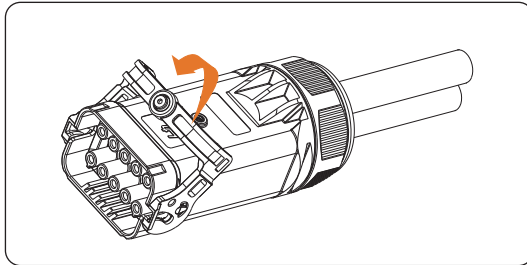

Figure 8-20 Pulling the latch up

Step 7: Insert the AC connector into the Grid & EPS port. If your operation is correct, the latch will automatically go back to the previous location. Lock the AC connector with an Allen key.

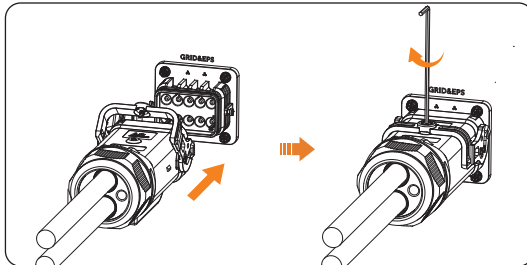

Figure 8-21 Inserting the AC connector into the port and locking it

 **WARNING!**

- Reinstall the cap for the AC & Grid port immediately after removing the connector from the port.

8.4 PV Connection

DANGER!

- When exposed to the sunlight, PV modules will generate lethal high voltage. Please take precautions.
- Before connecting the PV modules, make sure that both DC switch and AC breaker are disconnected, and that the PV module output is securely isolated from the ground.

WARNING!

- To mitigate the risk of fire, it is crucial to utilize a dedicated crimping tool specifically designed for PV installations to ensure secure and reliable connections.

CAUTION!

- Power is fed from more than one source and more than one live circuit.

Requirements for PV connection

- Open circuit voltage and operating voltage
 - » The open circuit voltage of each module array cannot exceed the maximum PV input voltage (1000 V) of the inverter. Otherwise, the inverter may be damaged.
 - » The operating voltage of PV modules must be within the MPPT voltage range (110-950 V) of the inverter. Otherwise, the inverter will prompt a **PV Volt Fault** alarm. Consider the impact of low temperature on the voltage of the photovoltaic panels, as lower temperatures tend to result in higher voltages.
- PV module
 - » One MPPT channel only connect to one string of PV modules. PV modules in the same string must be of the same brand and be tilted identically.
 - » The positive or negative pole of the PV modules should not be grounded.
 - » The positive cables of the PV modules must be connected to positive DC connectors. The negative cables of the PV modules must be connected to negative DC connectors.

NOTICE!

- The number of PV modules varies with the power of this series inverter. 4 kW, 5 kW, and 6 kW inverters can connect to two strings of PV modules; and 8 kW, 10 kW, 12 kW, and 15 kW inverters can connect to three strings of PV modules. Here only take connecting to one string of PV modules as an example, to show how to wire to the PV port.

Wiring procedures

Step 1: Strip the insulation of the PV cables to an appropriate length.

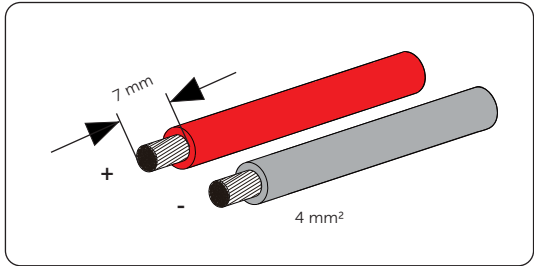

Figure 8-22 Stripping the PV cable

Step 2: Insert the stripped cables into the PV pin contacts (part C and part E). Make sure the the PV cable and PV pin contact are of the same polarity.

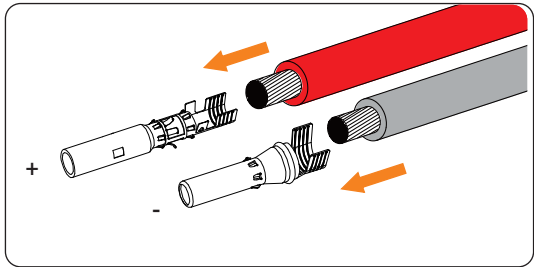

Figure 8-23 Inserting the PV pin contact

Step 3: Crimp it with the crimping tool for PV terminal. Pay attention to the crimping position.

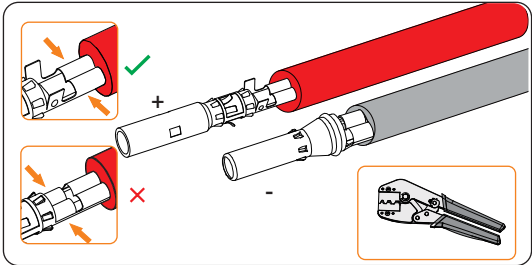

Figure 8-24 Crimping the terminal

Step 4: Thread the PV cables through the swivel nuts and insert them into the PV connectors (part D and part F) separately.

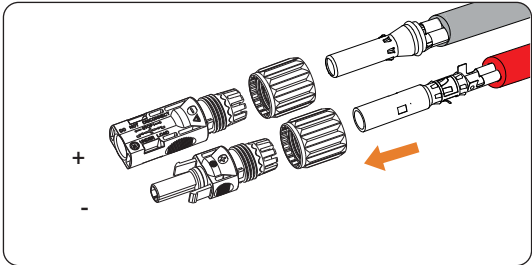

Figure 8-25 Threading the PV cable

Step 5: When hearing a sound of "click", gently pull the cables backward to ensure firm connection. Tighten the swivel nuts by twisting them clockwise. Verify that the PV connectors are of the correct polarity before connection.

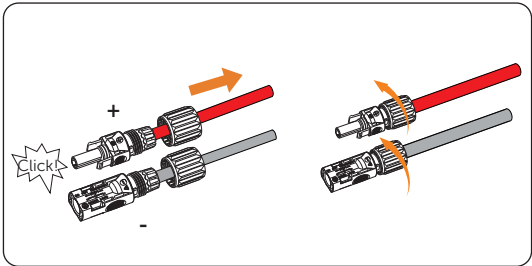

Figure 8-26 Securing the PV cable

Step 6: Measure the positive and negative voltage of the assembled PV connectors with a voltage measuring device which complies with the local regulation. Make sure the device operation voltage is less than 950 V.

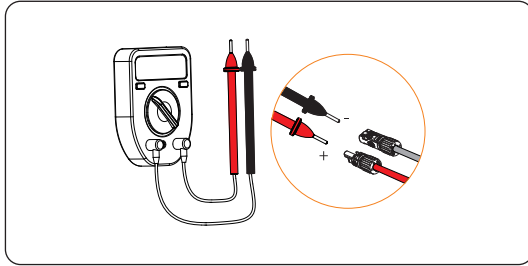

Figure 8-27 Measuring the voltage of PV connectors

NOTICE!

- If the voltage reading is negative, it indicates that the polarity of the DC input is incorrect. Please check whether the wiring of the measuring device is correct or PV connectors are installed correctly.

Step 7: Remove caps on the PV ports and connect the assembled PV connectors to the corresponding ports. When hearing a sound of "Click", it indicates your operation is correct. The PV+ on the string side must be connected to the PV+ on the inverter side, and the PV- on the string side must be connected to the PV- on the inverter side.

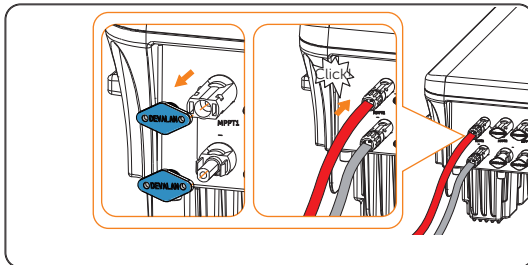

Figure 8-28 Connecting the PV cable

Step 8: If there are unused PV ports, take caps from the ports down and seal them with dustproof buckles.

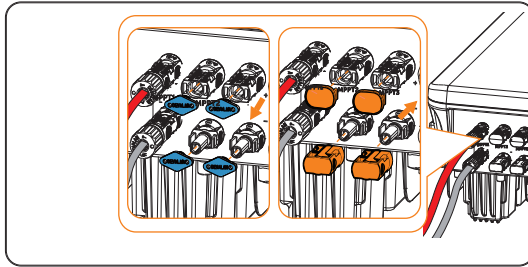

Figure 8-29 Sealing unused ports with buckles

 **WARNING!**

- According to the safety regulations, you must seal the unused ports with dustproof buckles (parts V and W).

8.5 Battery Power Cable Connection



- Before connecting cables, make sure the breaker, power button (if any) and DC switch (if any) of the battery all are disconnected or turned off.
- Always ensure correct polarity. Never reverse the polarity of the battery cables as this will result in inverter damage.

NOTICE!

- The power cable of battery is in the battery accessory pack. NOT in the scope of inverter's delivery.

Requirments for battery connection

- Battery
 - » SolaX Lithium-ion battery.
 - » The inverter is equipped with two independent battery ports, allowing for connection to two separate battery clusters at most. If two ports are used for two battery clusters, the maximum charge/discharge current for either of the two ports is 25 A. If only one port is used for one battery cluster, the maximum charge/discharge current for the port is 30 A.
 - » Make sure the input voltage of each BAT port is between 130 V and 800 V.
- Micro circuit breaker (MCB)
 - » If the battery is integrated with a readily accessible DC breaker, no additional DC breaker is required. If local regulations mandate the use of a DC MCB between the battery and the inverter, install a non-polar DC MCB.
 - » The nominal voltage of DC MCB should be larger than the maximum voltage of battery.
 - » For requirements on the current of MCB, refer to the related documentation. The following displays the maximum current of each battery model that fits this inverter:

Battery model	Max charge/discharge current
T-BAT-SYS-HV-S25	45A
T-BAT-SYS-HV-S36	50A
T-BAT-SYS-HV-3.0	30A
T-BAT-SYS-HV-S50E-D	50A
T-BAT-SYS-HV-S51	70A
T-BAT-SYS-HV-5.8	35A

- Battery configuration

Battery model	Configuration
T-BAT-SYS-HV-S50E-D	2-6 battery modules can be connected to a battery port.
T-BAT-SYS-HV-3.0	2-4 battery modules can be connected to a battery port.
T-BAT-SYS-HV-5.8	3-13 battery modules can be connected to a battery port.
T-BAT-SYS-HV-S25	
T-BAT-SYS-HV-S36	
T-BAT-SYS-HV-S51	

Wiring procedures

Step 1: Strip the insulation of the battery power cable to an appropriate length.

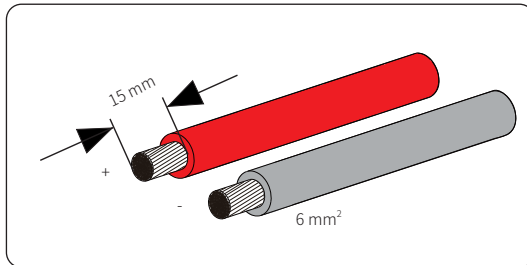

Figure 8-30 Stripping the battery cable

Step 2: Take out positive and negative battery connectors (part G and part H) from the accessory pack. Open the spring in the connector (as shown in the following picture). Insert the stripped positive and negative cables into the positive and negative connectors, until you see the cable in the connector.

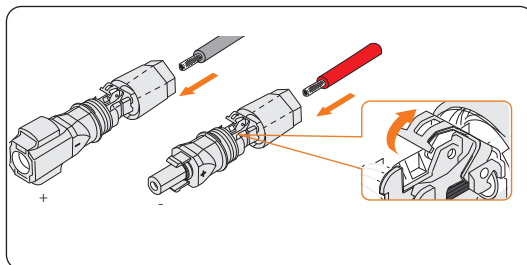

Figure 8-31 Inserting the cable into the battery connector

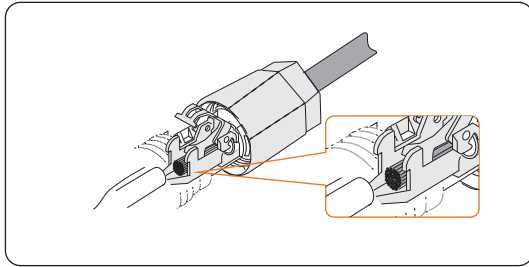

Figure 8-32 Seeing the cable in the connector

Step 3: Press the spring down until you hear a slight sound of "click", which indicates that the spring is closed successfully.

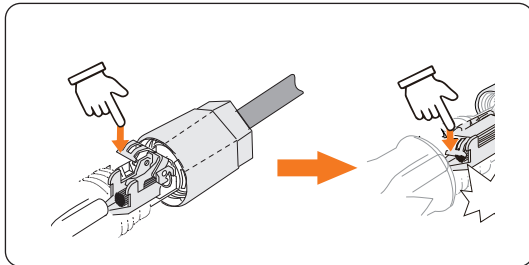

Figure 8-33 Closing the spring

Step 4: Move up the lower end of the connector and tighten the lower and upper ends of the connector together with a 15-mm open-ended wrench.

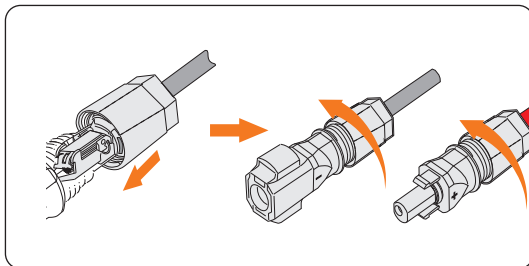

Figure 8-34 Tightening the connector

Step 5: Remove the caps on the battery port and connect the assembled battery connectors to the corresponding ports. A sound of "click" indicates that you connect it successfully.

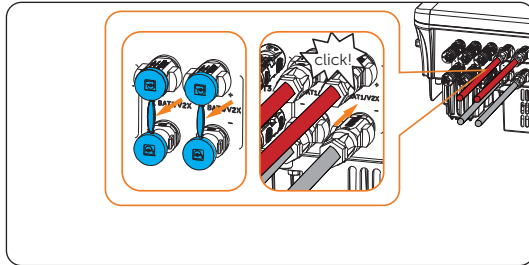

Figure 8-35 Connecting the battery connector

 **WARNING!**

- Keep the port caps in a proper place after connecting battery power cables to the inverter. Reinstall the caps immediately after removing the connectors from the ports.

8.6 COM 1 Communication Connection

Port COM 1 includes six subports: METER/CT, RS485, BMS 1, BMS 2, PARA 1 and PARA 2. Among them,

- METER/CT subport is used for connecting a meter or CT;
- RS485 subport is used for connecting an external devices, such as computer;
- BMS 1 and BMS 2 subports are used for connecting batteries; and
- PARA 1 and PARA 2 subports are used for connecting another inverters connected in parallel.

NOTICE!

- Because cables connect to the above subports via the same connector, you need to make an overall planning before wiring. That is, if you need to connect to multiple subports, do not tighten the connector before threading all required communication cables through the connector.

8.6.1 Pin Assignment of Port COM 1

The following picture shows the overall layout of Port COM 1 and definition of pins for each subport.

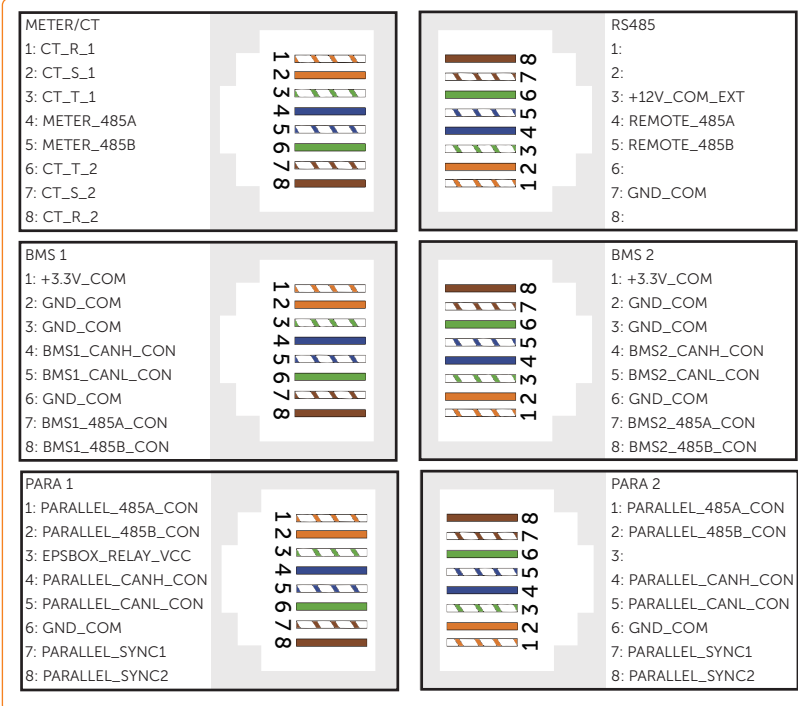
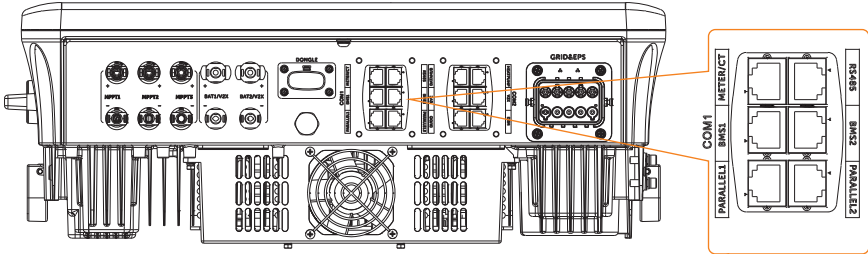

8.6.2 Meter/CT Connection

This section only introduces the wiring of the CT/Meter port of the inverter. For wiring procedures of the CT and meter side, refer to “15.7 CT/Meter Connection Scenarios”.

 CAUTION!

- The inverter will shut down and prompt a **Meter Fault** alarm if a meter/CT is connected to inverter improperly.
- Meters and CTs to be connected to the inverter must be authorized by SolaX. Otherwise, they might be incompatible with the inverter, resulting in inverter damage and working mode malfunction. SolaX will not be responsible for the impact caused by the use of other appliances.

Meter/CT pin assignment

Table 8-5 Meter/CT pin assignment

Pin No.	Definition	Description
1	CT_R_1	
2	CT_S_1	For connecting a CT
3	CT_T_1	
4	METER_485A	For connecting a meter
5	METER_485B	
6	CT_T_2	
7	CT_S_2	For connecting a CT
8	CT_R_2	

Meter/CT wiring procedure

Step 1: Loosen the securing screw on Port COM 1, and then hold latches on both sides of the connector enclosure to pull it out from the inverter.

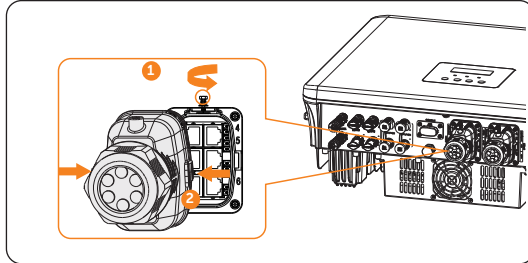

Figure 8-36 Disassembling the COM 1 connector

Step 2: Loosen the swivel nut of the enclosure, and then remove sealing plugs from the cable support sleeve as needed.

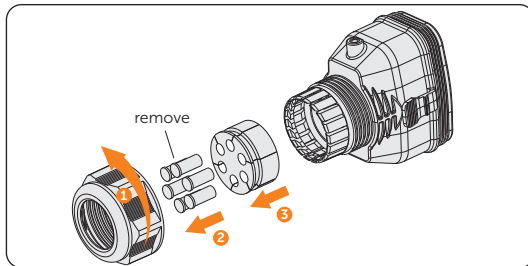

Figure 8-37 Disassembling the connector enclosure

NOTICE!

- When processing the cable support sleeve, do not remove the sealing plug from the hole you are not going to use.

Step 3: Thread the cable.

- Situation 1 — Cable with the RJ45 terminal: Thread the cable through the swivel nut, cable support sleeve and connector enclosure in sequence.

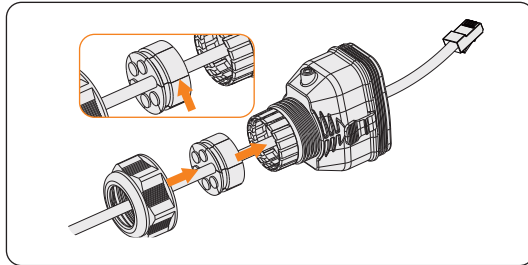

Figure 8-38 Threading the cable with the RJ45 terminal

- Situation 2 – Cable without the RJ45 terminal.
 - » Thread the cable through the swivel nut, cable support sleeve and connector enclosure in sequence. Strip the insulation of the cable to an appropriate length.

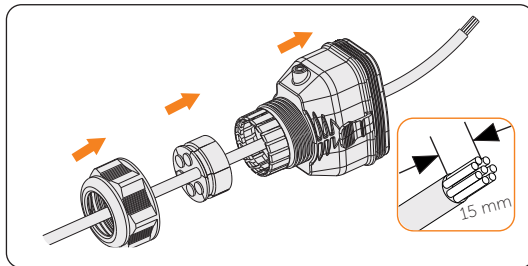

Figure 8-39 Threading the cable without the RJ45 terminal and stripping

- » Insert signal wires into the RJ45 terminal (part Q) and crimp them together with the RJ45 crimping plier. Before connecting to the inverter, test the crimped cable with a network cable tester.

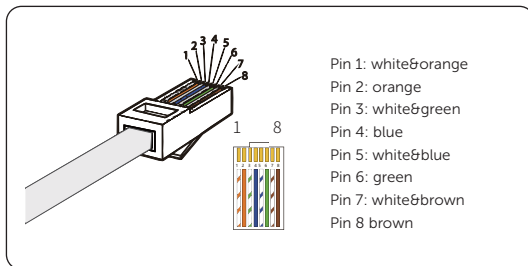

Figure 8-40 Inserting the signal wires and crimping the cable

NOTICE!

- If you need to connect to other subports in the COM 1 port, repeat Step 3 until all required cables are threaded through the connector.

Step 4: Insert the RJ45 terminal into the Meter/CT support of Port COM 1. Secure the assembled connector for Port COM 1.

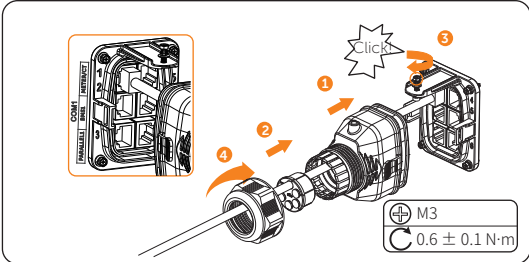

Figure 8-41 Connecting to Port COM 1

Step 5: Connect the other side of the cable to a wired meter or CT.

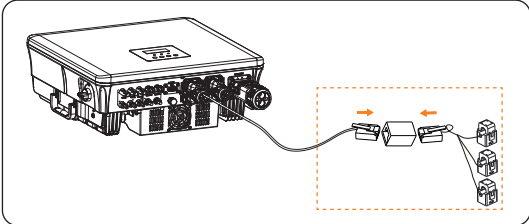

Figure 8-42 Connecting to CT

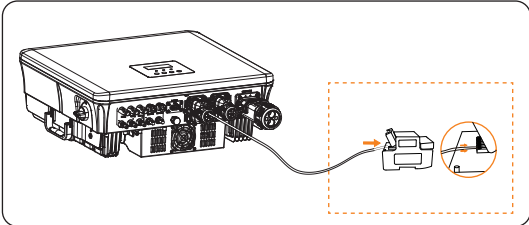

Figure 8-43 Connecting to meter

8.6.3 RS485 Communication Connection

Support RS485 is used for connecting to the external devices. All devices supporting the Modbus protocol, such as computer, can communicate with the inverter via the port, to further control the inverter.

Schematic diagram of connection to external device

An external device cannot be directly connected to the RS485 support. An RS485-to-USB converter plays the role of bridge between them.

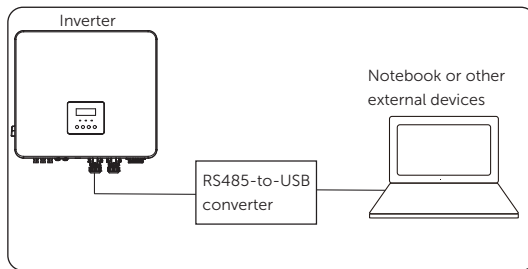

Communication connection wiring procedure

- Step 1:** Loosen the securing screw on Port COM 1, and then hold latches on both sides of the connector enclosure to pull it out from the inverter.
- Step 2:** Loosen the swivel nut on the enclosure anticlockwise, and then remove sealing plugs from the cable support sleeve as needed. Do not remove the sealing plugs from holes you are not going to use.
- Step 3:** Thread the cable through the swivel nut, cable support sleeve and connector enclosure in sequence.
- Step 4:** Secure the assembled connector on Port COM 1.
 - » Insert the connector enclosure into Port COM 1 of the inverter.
 - » Push the cable support sleeve into the connector enclosure.
 - » Tighten the M3 screw on Port COM 1 to fasten the connector enclosure. Torque: 0.6 ± 0.1 N·m
 - » Tighten the swivel nut clockwise, to complete connection.

NOTICE!

- Steps for RS485 communication connection are similar to those for meter/CT connection, which are not described in detail herein. For more details, please refer to "8.6.2 Meter/CT Connection".

8.6.4 BMS Communication Connection

Through communication supports BMS 1 and BMS 2, the inverter can be connected to two independent battery clusters in different capacities. The model of battery modules in either cluster must be the same.

BMS connection diagram

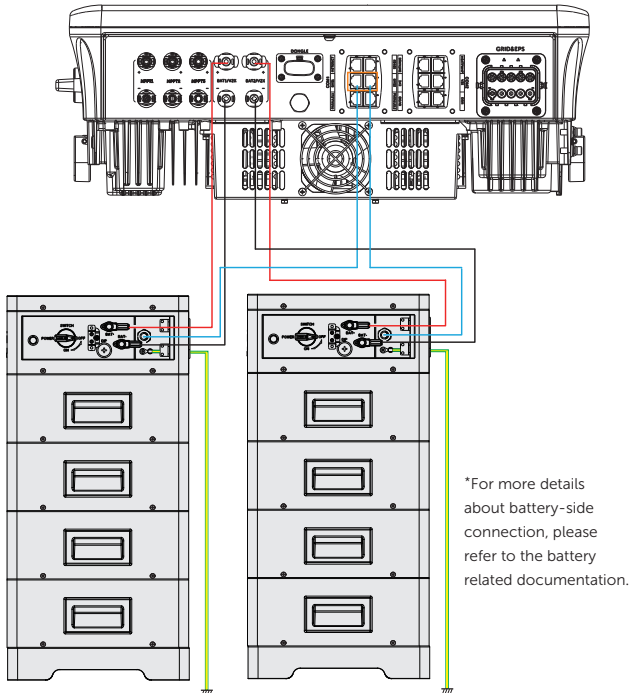

Figure 8-44 BMS connection diagram

BMS wiring procedure

- Step 1:** Loosen the securing screw on Port COM 1, and then hold latches on both sides of the connector enclosure to pull it out from the inverter.
- Step 2:** Loosen the swivel nut on the enclosure anticlockwise, and then remove sealing plugs from the cable support sleeve as needed. Do not remove the sealing plugs from holes you are not going to use.
- Step 3:** Thread the cable through the swivel nut, cable support sleeve and connector enclosure in sequence.
- Step 4:** Secure the assembled connector on Port COM 1.

- » Insert the connector enclosure into Port COM 1 of the inverter.
- » Push the cable support sleeve into the connector enclosure.
- » Tighten the M3 screw on Port COM 1 to fasten the connector enclosure.
Torque: 0.6 ± 0.1 N·m
- » Tighten the swivel nut clockwise, to complete connection.

NOTICE!

- The communication cable between a battery cluster and the inverter cannot exceed 3 meters.
- Steps for BMS communication connection are similar to those for meter/CT connection, which are not described in detail herein. For more details, please refer to “8.6.2 Meter/CT Connection”.

8.6.5 Parallel Connection

The inverter provides the parallel connection function. In the parallel system, once an inverter is set as master, the other inverters automatically become slave inverters. For details, please refer to “15.6 Application of Parallel Function”.

Parallel connection wiring procedure

- Step 1:** Loosen the securing screw on Port COM 1, and then hold latches on both sides of the connector enclosure to pull it out from the inverter.
- Step 2:** Loosen the swivel nut on the enclosure anticlockwise, and then remove sealing plugs from the cable support sleeve as needed. Do not remove the sealing plugs from holes you are not going to use.
- Step 3:** Thread the cable through the swivel nut, cable support sleeve and connector enclosure in sequence.
- Step 4:** Secure the assembled connector on Port COM 1.
- » Insert the connector enclosure into Port COM 1 of the inverter.
 - » Push the cable support sleeve into the connector enclosure.
 - » Tighten the M3 screw on Port COM 1 to fasten the connector enclosure.
Torque: 0.6 ± 0.1 N·m
 - » Tighten the swivel nut clockwise, to complete connection.

NOTICE!

- Steps for parallel connection are similar to those for meter/CT connection, which are not described in detail herein. For more details, please refer to “8.6.2 Meter/CT Connection”.

8.7 COM 2 Communication Connection

Port COM 2 includes six subports: DATAHUB, HEATPUMP, EVC, V2X, DI/DO, and DRM. Among them,

- DATAHUB subport is used for connecting a SolaX datahub;
- HEATPUMP subport is used for connecting a SolaX adapter box G2;
- EVC subport is used for connecting a SolaX EV charger;
- V2X subport is used for connecting a SolaX V2X module;
- DI/DO subport is used for connecting a generator or system switch; and
- DRM subport is used for connecting a power grid management device.

NOTICE!

- Because cables connect to the above subports via the same connector, you need to make an overall planning before wiring. That is, if you need to connect to multiple subports, do not tighten the connector before threading all required communication cables through the connector.

8.7.1 Pin Assignment of Port COM 2

The following picture shows the overall layout of Port COM 2 and definition of pins for each subport.

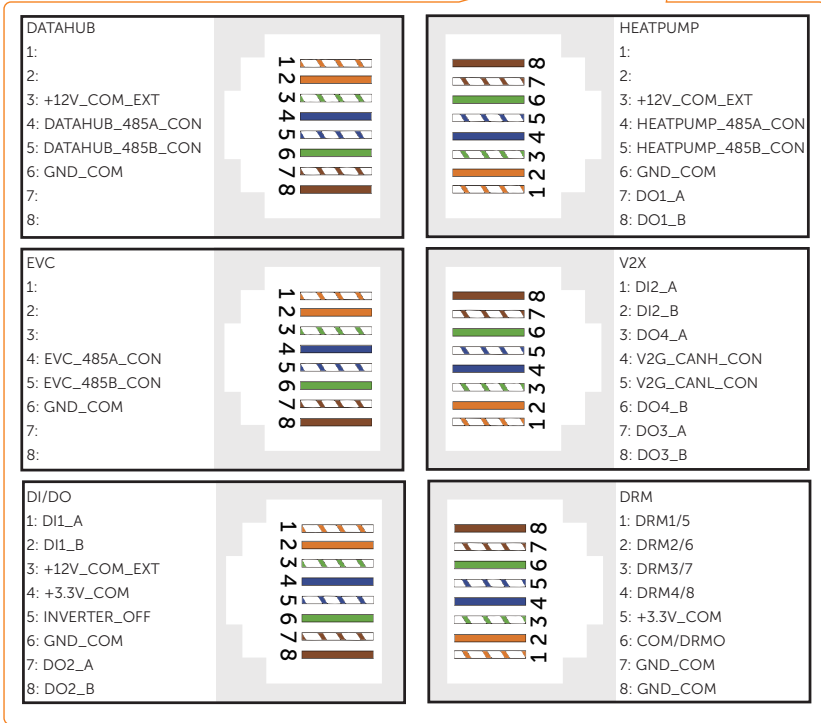
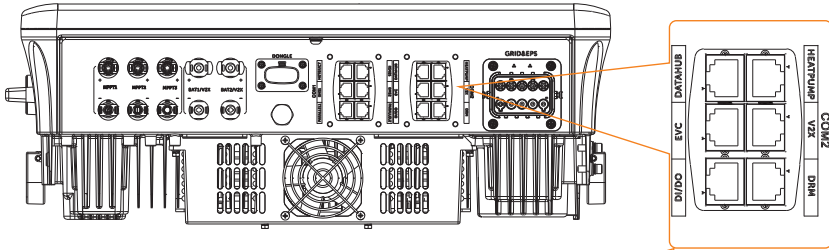

8.7.2 Datahub, heatpump, and EVC communication connection

Datahub, heatpump, and EV charger all can communicate with the inverter via corresponding supports in Port COM 2. As steps for datahub, heatpump, and EVC communication connection are similar, which are not described in detail, you can refer to the same steps below. For details about application scenario and settings for datahub, heatpump, and EV charger, please refer to [“15.4 Application of DataHub”](#), [“15.2 Application of Adapter Box G2”](#), and [“15.3 Application of EV-Charger”](#) respectively.

Datahub, heatpump, and EVC wiring procedure

Step 1: Loosen the securing screw on Port COM 2, and then hold latches on both sides of the connector enclosure to pull it out from the inverter.

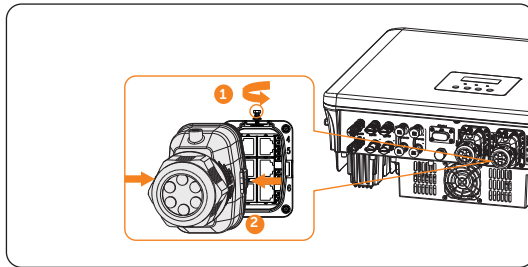

Figure 8-45 Disassembling the COM 2 connector

Step 2: Loosen the swivel nut of the enclosure, and then remove sealing plugs from the cable support sleeve as needed.

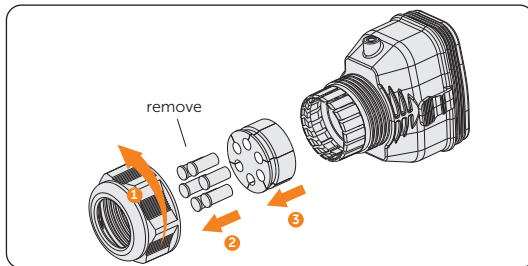

Figure 8-46 Disassembling the connector enclosure

NOTICE!

- For the hole in the cable support sleeve you are not going to use, do not remove the sealing plug from it.

Step 3: Thread the cable.

- Situation 1 — Cable with the RJ45 terminal: Thread the cable through the swivel

nut, cable support sleeve and connector enclosure in sequence.

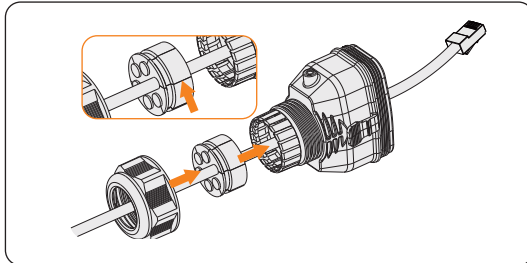

Figure 8-47 Threading the cable with the RJ45 terminal

- Situation 2 — Cable without the RJ45 terminal.
 - » Thread the cable through the swivel nut, cable support sleeve and connector enclosure in sequence. Strip the insulation of the cable to an appropriate length.

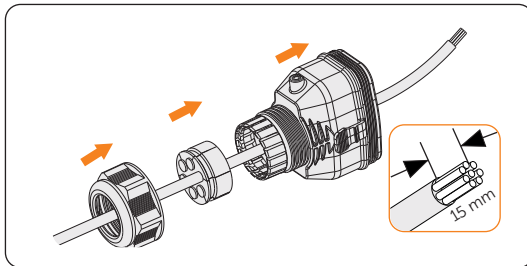

Figure 8-48 Threading the cable without the RJ45 terminal and stripping

- » Insert signal wires into the RJ45 terminal and crimp them together with the RJ45 crimping plier. Before connecting to the inverter, test the crimped cable with a network cable tester.

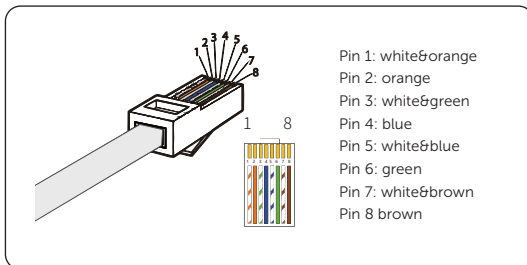

Figure 8-49 Inserting the signal wires and crimping the cable

NOTICE!

- If you need to connect to other supports in the COM 2 port, repeat Step 3 until all required cables are threaded through the connector.

Step 4: Insert the RJ45 terminal into the DATAHUB support of Port COM 2. Secure the assembled connector for Port COM 2.

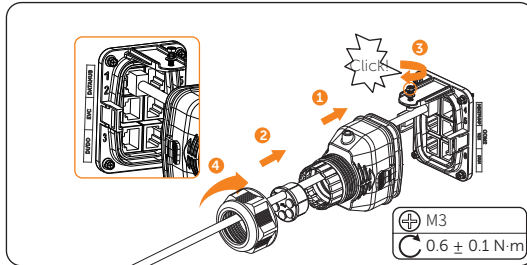

Figure 8-50 Connecting to Port COM 2

Step 5: Connect the other side of the cable to a datahub, heatpump, or EVC.

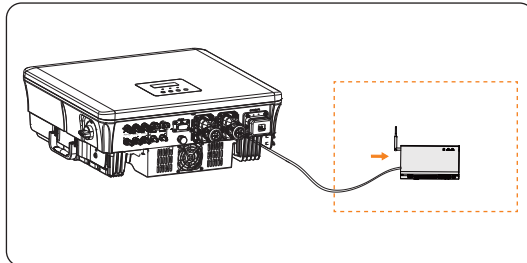

Figure 8-51 Connecting to datahub

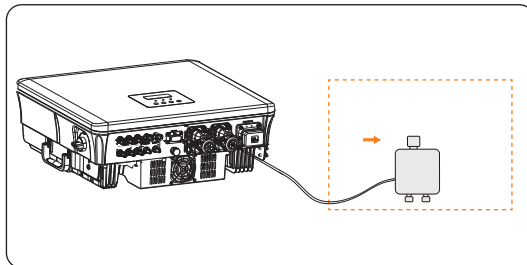

Figure 8-52 Connecting to heatpump

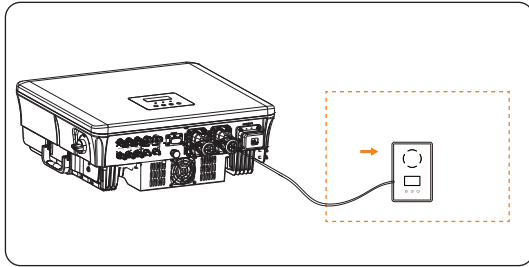

Figure 8-53 Connecting to EVC

8.7.3 DI/DO Communication Connection

The DI/DO subport is used to connect a generator or system switch through dry contact.

To enhance safety and reduce the risk of injury, you can install the system switch in a readily accessible location through dry contact connection. In the event of an emergency, the system switch can be easily reached and pressed to promptly switch off the entire system, ensuring a swift response and preventing further harm.

For details about generator, please refer to "15.1 Application of Generator".

DI/DO pin assignment

Table 8-6 DI/DO pin assignment

Pin	Definition	Description
1	DI1_A	Dry contact for input
2	DI1_B	
3	12V_COM_EXT	
4	3.3V_COM	System off signal
5	INVERTER_OFF	
6	GND	
7	DO2_A	Dry contact for output
8	DO2_B	

NOTICE!

- If the device is strongly interfered by the surroundings, it is recommended to use shielding cables and ground the shielding layer of the cables through Pin 6.

System switch connection diagram

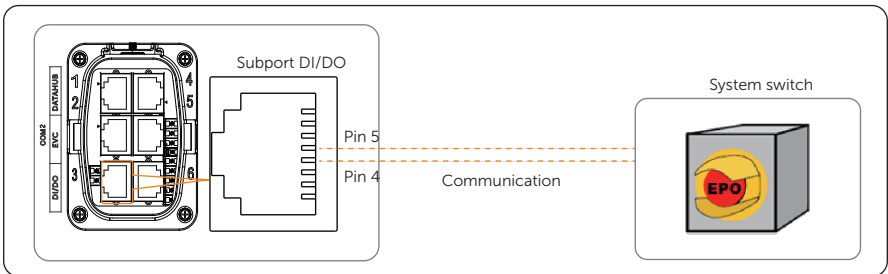

Figure 8-54 System switch connection diagram

When a system switch is pressed, **OFF MODE (INV BTN)** will be displayed on the LCD and the system will be powered off. To release the switch, press it again. You need to prepare a system switch by yourself.

DI/DO wiring procedure

- Step 1:** Loosen the securing screw on Port COM 2, and then hold latches on both sides of the connector enclosure to pull it out from the inverter.
- Step 2:** Loosen the swivel nut on the enclosure anticlockwise, and then remove sealing plugs from the cable support sleeve as needed. Do not remove the sealing plugs from holes you are not going to use.
- Step 3:** Thread the cable through the swivel nut, cable support sleeve and connector enclosure in sequence.
- Step 4:** Secure the assembled connector on Port COM 2.
- » Insert the connector enclosure into Port COM 2 of the inverter.
 - » Push the cable support sleeve into the connector enclosure.
 - » Tighten the M3 screw on Port COM 2 to fasten the connector enclosure.
Torque: 0.6 ± 0.1 N·m
 - » Tighten the swivel nut clockwise, to complete connection.

NOTICE!

- Steps for DI/DO connection are similar to those for datahub, heatpump or EVC connection, which are not described in detail herein. For details, please refer to “[8.7.2 Datahub, heatpump, and EVC communication connection](#)”.

8.7.4 V2X Connection

The V2X support is used for connecting to a V2X module. For more details about it, please to the corresponding user manual.

V2X wiring procedure

- Step 1:** Loosen the securing screw on Port COM 2, and then hold latches on both sides of the connector enclosure to pull it out from the inverter.
- Step 2:** Loosen the swivel nut on the enclosure anticlockwise, and then remove sealing plugs from the cable support sleeve as needed. Do not remove the sealing plugs from holes you are not going to use.
- Step 3:** Thread the cable through the swivel nut, cable support sleeve and connector enclosure in sequence.
- Step 4:** Secure the assembled connector on Port COM 2.
- » Insert the connector enclosure into Port COM 2 of the inverter.
 - » Push the cable support sleeve into the connector enclosure.
 - » Tighten the M3 screw on Port COM 2 to fasten the connector enclosure.
Torque: $0.6 \pm 0.1 \text{ N}\cdot\text{m}$
 - » Tighten the swivel nut clockwise, to complete connection.

NOTICE!

- Steps for V2X connection are similar to those for datahub, heatpump or EVC connection, which are not described in detail herein. For details, please refer to "[8.7.2 Datahub, heatpump, and EVC communication connection](#)".

8.7.5 DRM & Ripple Control Connection

DRED (Demand Response Enabling Device) and RCR (Ripple Control Receiver) are different grid management manners in different country or region. This section introduces the wiring method for a DRED and an RCR.

DRED and RCR connect to the inverter through the same port DRM. In actual situations, users can only select one of them according to the requirements of the public grid.

DRM

According to AS/NZS 4777.2, the inverter needs to support the function of demand response mode (DRM). With an external control box, active or reactive power regulation can be realized in a timely and fast manner, and the inverter can run stably during the process of regulation.

This inverter supports three modes: DRM 0, DRM 1 and DRM 5.

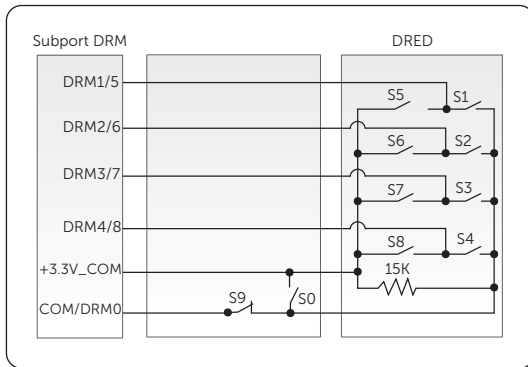

Figure 8-55 DRED connection diagram

Table 8-7 Description of DRM

Mode	Pin No.	Requirement
DRM 0	Pin 6	<ul style="list-style-type: none"> When S0 is closed, the inverter is switched off. When S0 is opened, the inverter restores to be connected to the grid.
DRM 1	Pin 1	<ul style="list-style-type: none"> When S1 is closed, the inverter does not input active power.
DRM 5	Pin 1	<ul style="list-style-type: none"> When S5 is closed, the inverter does not output active power.

Ripple Control

In Germany and parts of Europe, grid companies use RCRs to convert grid management signals into dry contact signals. Therefore, the inverter needs to receive the grid management signals in the dry contact manner.

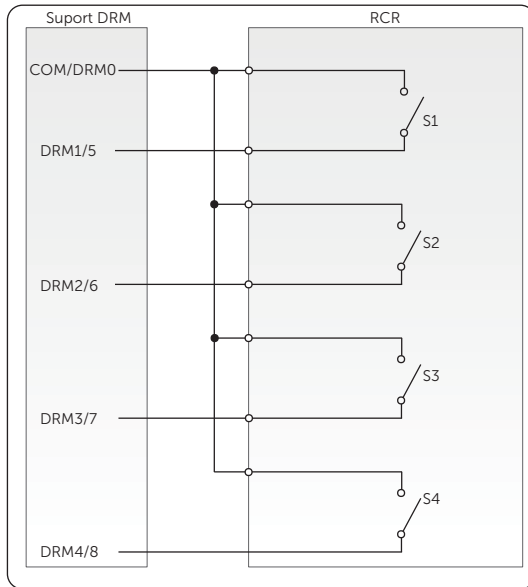

Figure 8-56 RCR connection diagram

Table 8-8 Method for asserting DI mode

S1	S2	S3	S4	Switch operation on RCR	Output power (in % of rated AC output power)
0	0	0	0	None	100% (configure as needed)
1	0	0	0	Close S1	100%
0	1	0	0	Close S2	60%
0	0	1	0	Close S3	30%
1	1	0	0	Close S1 and S2	0% (disconnect from the public grid)

DRM/Ripple control wiring procedure

Step 1: Loosen the securing screw on Port COM 2, and then hold latches on both sides of the connector enclosure to pull it out from the inverter.

Step 2: Loosen the swivel nut on the enclosure anticlockwise, and then remove sealing

plugs from the cable support sleeve as needed. Do not remove the sealing plugs from holes you are not going to use.

Step 3: Thread the cable through the swivel nut, cable support sleeve and connector enclosure in sequence.

Step 4: Secure the assembled connector on Port COM 2.

- » Insert the connector enclosure into Port COM 2 of the inverter.
- » Push the cable support sleeve into the connector enclosure.
- » Tighten the M3 screw on Port COM 2 to fasten the connector enclosure.
Torque: 0.6 ± 0.1 N·m
- » Tighten the swivel nut clockwise, to complete connection.

NOTICE!

- Steps for DRM/ripple control connection are similar to those for datahub, heatpump or EVC connection, which are not described in detail herein. For details, please refer to ["8.7.2 Datahub, heatpump, and EVC communication connection"](#).

8.8 Monitoring Connection

A Wi-Fi + LAN monitoring module can connect to the inverter through the Dongle Pocket port. The module supports two communication modes of Wi-Fi and LAN, so that it can transmit device data to the SolaX Cloud in real time. With a monitoring module, users can monitor, manage, and maintain an inverter by means of mobile phone or web page. If you are interested in it, contact us to purchase it.

Monitoring connection diagram

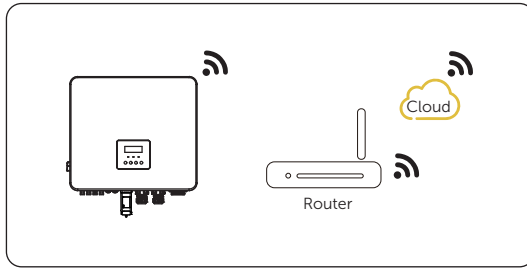

Figure 8-57 Wi-Fi mode connection diagram

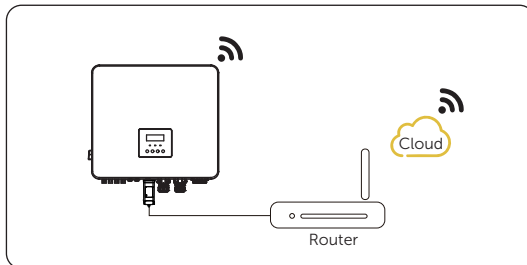

Figure 8-58 LAN mode connection diagram

Monitoring wiring procedure

Wi-Fi mode:

- a. Assemble the dongle.

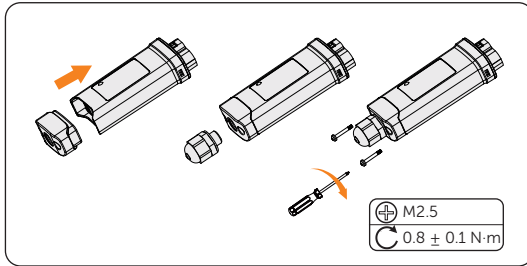

Figure 8-59 Assembling the dongle

- b. Plug the dongle into the inverter.

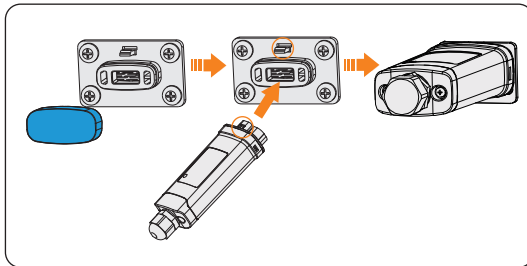

Figure 8-60 Connecting the dongle

CAUTION!

- The buckles on the inverter and dongle must be on the same side. Otherwise, the dongle may be damaged.

NOTICE!

- The distance between the router and the inverter must be less than 100 meters. If there are walls between them, the distance must be less than 20 meters.
- If the Wi-Fi signal is not strong enough, install a Wi-Fi signal booster.
- You can configure the Wi-Fi only after the inverter is powered on. For details about Wi-Fi configuration, refer to the guide documents in the SolaxCloud App.

LAN mode:

- a. Disassemble the waterproof connector into components 1, 2, 3 and 4; Component 1 is not used. Keep it in a safe place.

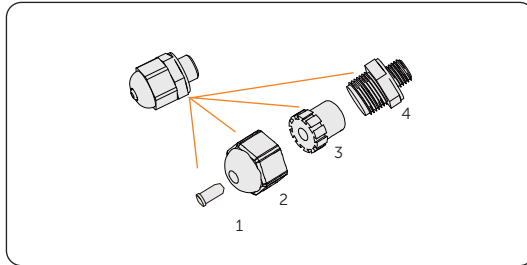

Figure 8-61 Disassembling the waterproof connector

- b. Assemble the dongle.

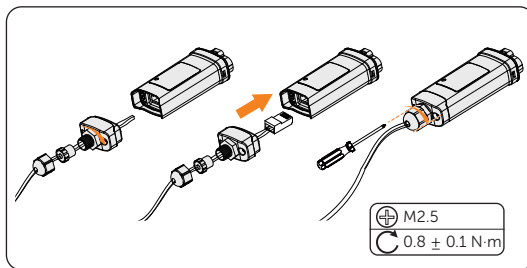

Figure 8-62 Assembling the dongle

- c. Plug the dongle into the inverter.

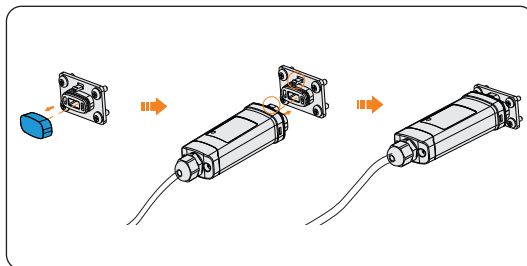

Figure 8-63 Connecting the dongle

 CAUTION!

- The buckles on the inverter and dongle must be on the same side. Otherwise, the dongle may be damaged.

9 System Commissioning

9.1 Checking before Power-on

No.	Item	Checking details
1	Installation	The inverter is installed correctly and securely. The battery is installed correctly and securely. Other devices (if any) are installed correctly and securely.
2	Wiring	All DC, AC cables and communication cables are connected correctly and securely. The meter/CT is connected correctly and securely. The ground cable is connected correctly and securely.
3	Breaker	All the DC breakers and AC breakers are disconnected.
4	Connector	The external AC and DC connectors are connected. The connector for the Grid & EPS port is connected correctly and securely.
5	Unused terminal	Unused ports are covered with waterproof caps or dustproof buckles.
6	Screw	All the screws are tightened.

9.2 Powering on the System

Step 1: Connect the DC breaker, turn on the DC switch, and check whether the LCD works normally.

- » If it works normally, press the **Enter** key to go to the main menu. Select **System On/Off** and set **Switch to On**.
- » If it works abnormally, refer to ["12.2 Troubleshooting"](#) for the solution.

Step 2: Connect the AC breaker and wait for the inverter to power on.

Step 3: Complete meter or CT settings and check their connection status. For the specific method, refer to ["Meter/CT Settings"](#) and ["15.7 CT/Meter Connection Scenarios"](#).

Step 4: Switch on the battery or the breaker, button, DC switch of the battery (refer to documentation of the battery manufacturer).

Step 5: Set **Forced Discharge** and **Forced Charge** by selecting **Menu>Mode Select>Manual** to verify whether the charging and discharging of battery is normal.

9.3 DC Switch

This series of inverters are provided with two types of DC switches:

- General type (without lock): Applicable to most countries and regions.
- Lockable type (with lock): Applicable to Australia and New Zealand only.

Status of DC switch

The DC switch has 3 states: ON, OFF, and OFF+Lock (only available to the lockable switch). By default, the DC switch is in the position of OFF.

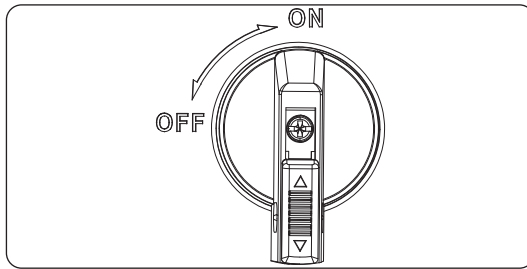

Figure 9-64 ON state

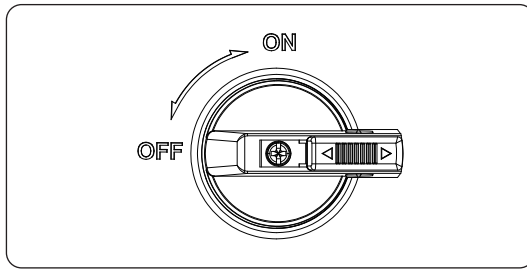

Figure 9-65 OFF state

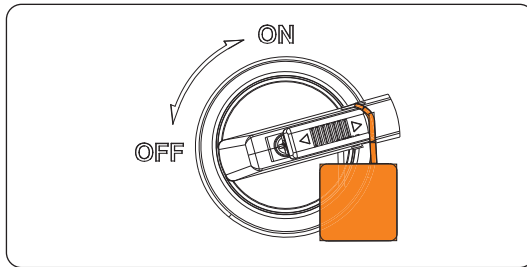

Figure 9-66 OFF+Lock state

Operation of DC switch

- Turn on the DC switch: Rotate the DC switch from OFF to ON.

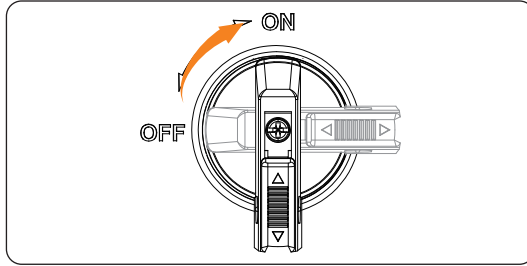

Figure 9-67 Turning on the DC switch

- Turn off the DC switch: Rotate the DC switch from ON to OFF.

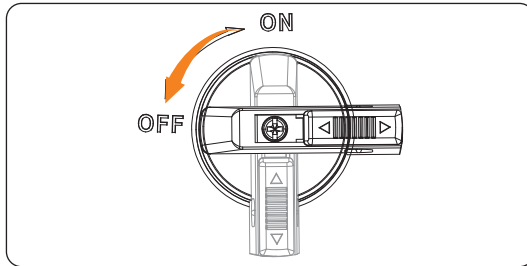

Figure 9-68 Turning off the DC switch

The following operations are only available to the lockable switch.

- Lock the DC switch:
 - a. Rotate the lock to the left side of OFF;
 - b. Push the lock inward (as shown in the diagram below);
 - c. Secure the DC switch with a lock (Please prepare a lock in advance).

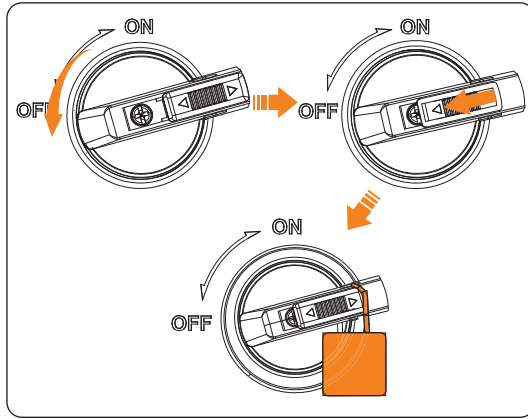

Figure 9-69 Locking the DC switch

- Unlock the DC switch:
 - a. Push the lock outward (as shown in the diagram below);
 - b. Wait for it to move to OFF.

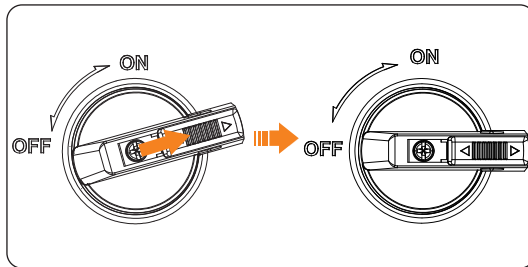

Figure 9-70 Unlocking the DC switch

10 Operation on LCD

10.1 Introduction of Control Panel

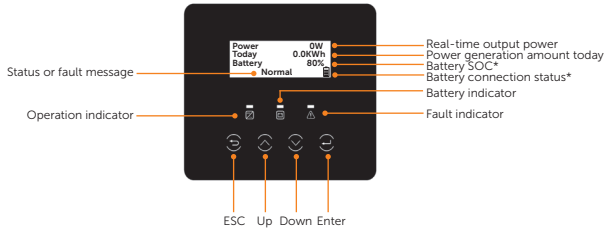

Figure 10-1 Control Panel

- In normal state, the LCD will display "Power", "Power generation amount today", "Battery SOC" and "Battery connection status".
- In abnormal state, the fault message and error code will be displayed. Please refer to "12.2 Troubleshooting" for corresponding solutions.

Table 10-1 Description of indicators













Item	Status		Description
 Operation indicator		Always on	The inverter is in normal state.
		Flicker	The inverter is in waiting or checking state.
 Fault indicator		Always on	A fault occurs to the inverter.
 Battery indicator		Always on	At least one battery port works normally.
		Flicker	Both of the battery ports are in idle state.

Table 10-2 Description of keys

Key	Description
 ESC	Exit from the current interface or function.
 Up	Move the cursor up or increase the value.
 Down	Move the cursor down or decrease the value.
 Enter	Confirm the current selection.

Note:

- Battery connection status: When the icon flickers, it indicates that no battery cluster communicates with the inverter normally.
- Battery SOC: The percentage of the remaining battery energy to the total battery capacity.

10.2 Introduction of Menu Interface

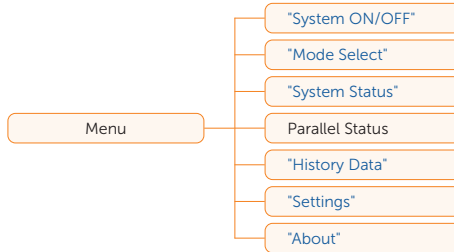

There are 7 submenus in the menu that can be selected for relevant setting operations.

- **System ON/OFF:** Switch on and off the inverter.
- **Mode Select:** Set the working mode for the inverter. The working modes include **Self Use Mode, Feed-in Priority, Backup Mode, Manual, Peaking Shaving Mode,** and **TOU.**

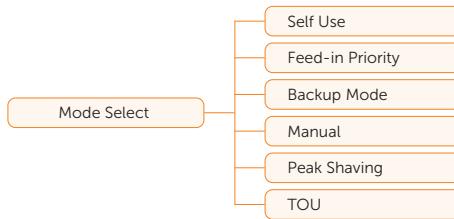

- **System Status:** Display the real-time system information, including MPPT, battery, on-grid, EPS, meter/CT and communication status.

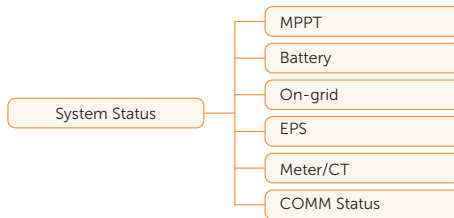

- **Parallel Status:** Display the status data of all devices at the LCD of the master inverter when multiple inverters are connected in parallel. Specifically, it shows the grid connection status of all slave inverters and the number of slave inverters connecting to the grid successfully.
 - » ○ indicates that a device is connected to the grid successfully.
 - » × indicates that a device failed to connect to the grid.

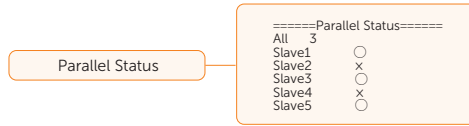

- **History Data:** Display the history data of **On-grid**, **EPS**, **E_Feedin**, **E_USERDEF** and **Error Log**.

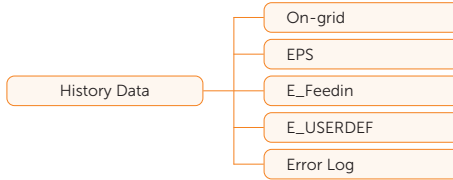

- **Settings:** Set parameters for the inverter. It includes **User Settings** and **Advanced Settings**.

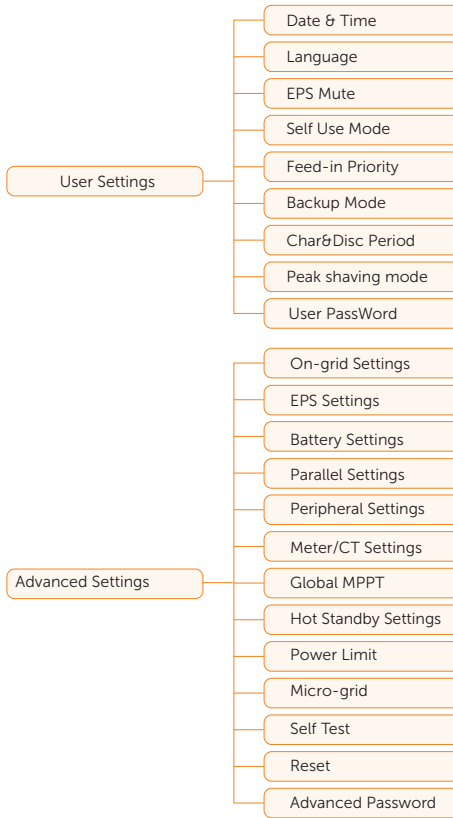

- **About:** Display the information about **Inverter**, **Battery 1**, **Battery 2** and **Internal code**.

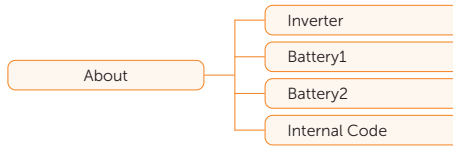

10.3 System ON/OFF

Setting path: **Menu>System ON/OFF**

Select **ON** or **OFF** to switch on and off the inverter. The switch is set to be **ON** by default. When you select **OFF**, the inverter stops running and displays **System OFF**.

```
====System ON/OFF====
Switch
      >  ON  <
```

10.4 Mode Select

Selecting path: **Menu>Mode Select**

When the inverter is in on-grid state, there are 6 working modes for you to choose: Self use mode, Feed-in Priority, Backup, Peak shaving mode, TOU mode and Manual. You can choose the working modes according to your lifestyle and environment. Please refer to "2.7 Working Mode" for introduction of the modes and "10.7.1 User Settings" for specific settings of each mode.

```
====Mode Select====
>Self Use
  Feed-in Priority
  Backup Mode
```

10.5 System Status

Displaying path: **Menu>System Status**

The system status includes: MPPT status, Battery status, On-grid data (about power sold to and taken from the grid), EPS data, Meter/CT, and communication status:

- MPPT status: This interface displays the voltage, current, and frequency of MPPT 1, MPPT 2, and MPPT 3 (if any). 4 kW, 5 kW, and 6 kW inverters can connect to 2 MPPTs at most; and 8 kW, 10 kW, 12 kW, and 15 kW inverters can connect to 3 MPPTs at most.

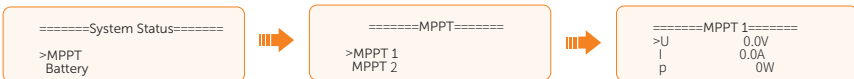

- Battery status: There will be information of **Battery1** and **Battery2** displayed here. It shows the status of each battery terminal, including the voltage, current, power, SOC, cell temperature and BMS connection status. Positive value means charging; Negative value means discharging.

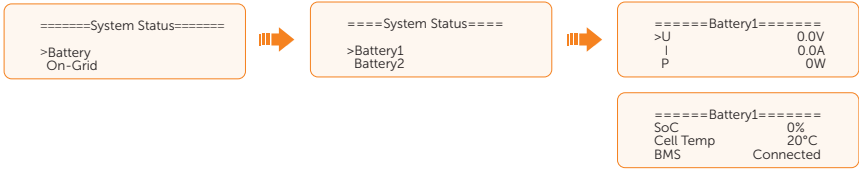

- On-grid data: It displays the voltage, current, frequency, and output power of Grid port when the inverter is connected to the grid. The "A", "B" and "C" in **On-grid A**, **On-grid B** and **On-grid C** refers to L1, L2 and L3 respectively. Here take **On-grid A** as an example. If the value is positive, it indicates power output. If the value is negative, it indicates power input.

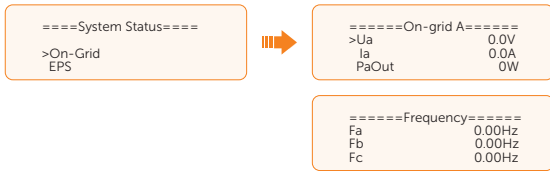

- EPS data: It shows the apparent power, voltage, current, active power and frequency of the EPS port when the inverter is disconnected from the grid. The "A", "B" and "C" in **EPS A**, **EPS B** and **EPS C** refers to L1, L2 and L3 respectively. The figure below displays details about **EPS A**.

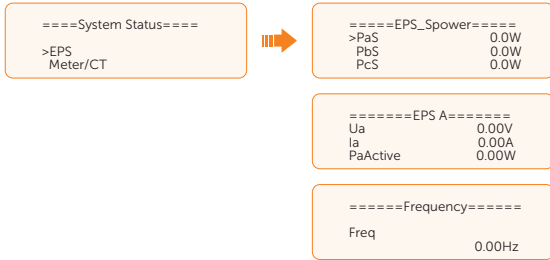

- Meter/CT: It shows the feed-in power of L1, L2 and L3 detected by the connected meter or CT. If the Pfeedin value is positive, it indicates power fed into the grid. If the Pfeedin value is negative, it indicates power taken from the grid.



- COMM Status:



10.6 History Data

Displaying path: **Menu>History Data**

After entering the **History Data** interface, the data of **On-grid**, **EPS**, **E_Feedin**, **E_USERDEF**, **Error Log** will be displayed on the LCD as follows:

- **On-grid**: A record of the output and input electric energy of the inverter today and the total (through the Grid port).
 - » **Output Today**: Output electric energy of the inverter today.
 - » **Output Total**: Total output electric energy since the inverter activated for the first time.
 - » **Input Today**: Input electric energy of the inverter today.
 - » **Input Total**: Total input electric energy since the inverter activated for the first time.

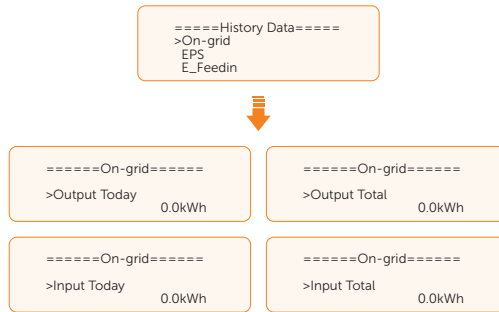

- **EPS**: The output electric energy of the inverter today and in total, when it is disconnected from the grid (through the EPS port).

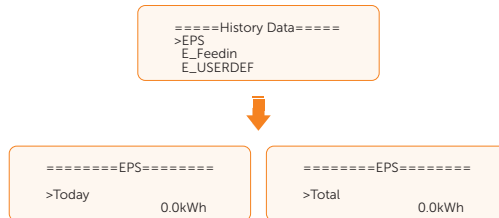

- **E_Feedin**: The total electricity fed into or taken from the grid since the inverter activated for the first time and on that day (detected by Meter/CT).
 - » **Feedin Today**: Electricity sold to grid today.
 - » **Feedin Total**: Total electricity sold to grid since the inverter activated for the first time.
 - » **Consume Today**: Electricity bought from grid today.

- » **Consume Total:** Total electricity bought from grid since the inverter activated for the first time.

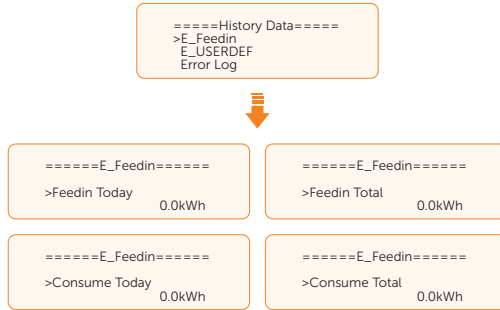

- **E_USERDEF:** The output electricity of the connected on-grid inverter today and in total (detected by Meter 2). This function is only available when meter 2 is connected.

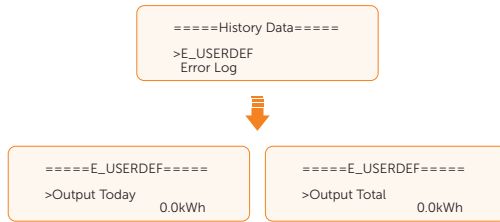

- **Error Log:** Display the latest 6 error messages. Information contains error occurrence date and time, error code and error description.



10.7 Settings

Settings includes User Settings and Advanced Settings.

10.7.1 User Settings

Setting path: **Menu>Setting>User Settings**

NOTICE!
The default password for User Settings is "0 0 0 0".

Setting Date & Time

You can set the current date and time of the installation site.

The display format is "2023-06-16 14:00", in which the first four numbers represent the year (e.g. 2000~2099); the fifth and sixth numbers represent the month (e.g. 01~12); the seventh and the eighth numbers represent the date (e.g. 01~31). The remaining numbers represent the time.



Setting Language

This inverter provides multiple languages for you to choose, such as English, Deutsch, francais, Polskie, Espanol, Português. The default language is English.



Setting EPS Mute

When the inverter is running in EPS mode, you can choose whether to turn on the buzzer.

- If yes, the buzzer mutes.
- If not, the buzzer will sound every 4s when "Battery SOC > Min EPS SOC". When "Battery SOC = Min EPS SOC", the buzzer will sound every 0.4s. This function is turned off by default.



Setting Self Use Mode

Please refer to "2.7.1 Self-use Mode" for working logic of this mode.

In this mode, you can set:

- the minimum SOC of the battery.
- whether to take power from the grid to charge the battery and the target value of battery charging.

The specific settings are as follows:

- **Min SOC:** Default: 10%; range: 10%~100%
 - » The minimum SOC of the battery. The battery will not discharge power when its remaining power reaches this value.



- **Charge from grid:**
 - » You can set whether to take power from the grid to charge the battery in the forced charging period. When **Charge from grid** is set to **Enable**, the grid power is allowed to charge the battery; when it is set to **Disable**, the grid power is not allowed to charge the battery.



- **Charge battery to:** Default: 30%; range: 10%~100%
 - » Set the target SOC to charge the battery from grid in the forced charging period (applicable only when the **Charge from grid** is enabled).
 - » You can set a target value, i.e. during the forced charging period, the inverter will use both PV & grid power to charge the battery to the target value. After the target value is reached, if the PV still has sufficient power (enough for load and there is excess power), the inverter will continue to charge the battery.

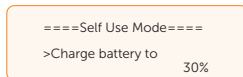

Setting Feed-in Priority

Please refer to "2.7.2 Feed-in Priority" for working logic of this mode.

In this mode, you can set the minimum battery SOC and battery charging target value.

- **Min SOC:** Default: 10%; range: 10%~100%
 - » The minimum SOC of the battery. The battery will not discharge power when

the SOC of the battery reaches this value.



- **Charge battery to:** Default: 100%; range: 10%~100%
 - » Set the target SOC to charge the battery from grid in the forced charging period.
 - » You can set a target value, i.e. during the forced charging period, the inverter will use both PV & grid power to charge the battery to the target SOC value. After the battery SOC meets the target value, if the PV power is still sufficient, the surplus power will be fed into the grid.

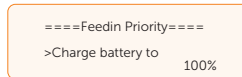

Setting Backup Mode

Please refer to "2.7.3 Backup Mode" for working logic of this mode.

- **Min SOC:** Default: 30%; range: 15%~100%
 - » The minimum SOC of the battery. The battery will not discharge power when the SOC of the battery reaches this value.



- **Charge battery to:** Default: 50%; range: 30%~100%
 - » In this mode, the "charge from grid" function is turned on by default, and customers can set the target value by themselves. That is, during the forced charging period, the inverter will use both PV & grid power to charge the battery to the target value. If the PV power is still sufficient (enough for load and there is excess power), the inverter will continue to charge the battery.

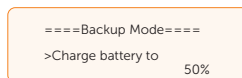

Setting Char&Disc Period

Here you can set the **Forced Charge Period** and **Allowed Discharge Period**.

If two charging and discharging periods are needed, enable the **Function Control** to activate **Char&Disc Period2**.

- **Char&Disc Period:** You can set the charge and discharge time according to your own needs. The default time axis of the system is 24h.

- » **Forced Charge Period Start Time:** Time to start charging; default: 00:00; range: 00:00~23:59
- » **Forced Charge Period End Time:** Time to stop charging; default: 00:00; range: 00:00~23:59
- » **Allowed Disc Period Start Time:** Time allowing to start discharging (The charging or discharging of the battery depends on the working mode.); default: 00:00; range: 00:00~23:59
- » **Allowed Disc Period End Time:** Time to stop discharging; default: 23:59; range: 00:00~23:59

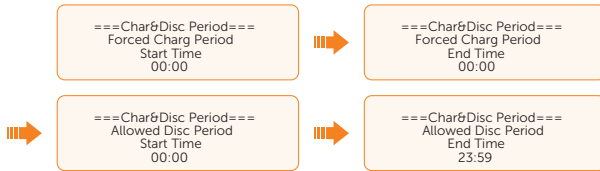

- **Char&Disc Period2:** It is closed by default. Enable it if you need to set another time period. The logic of this period is same with that of **Char&Disc Period**.

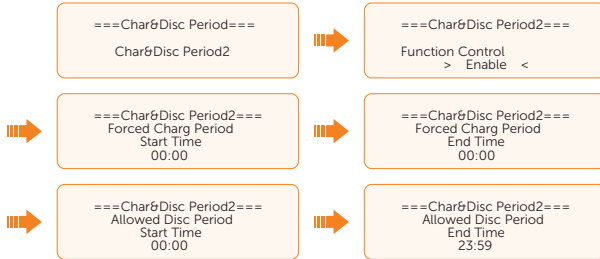

NOTICE!

- The charging and discharging period is only applicable for self use mode, feed-in priority and backup mode.
- For the period which is not set as the forced charging period or allowed discharging period, the battery can be charged but cannot discharge power.
- For the period which is set as the forced charging period and allowed discharging period at the same time, the battery will be charged forcibly.

Setting Peak shaving mode

Please refer to "2.7.4 Peak Shaving Mode" for the working logic of this mode.

- **DisChgPeriod1:** To set **ShavingStartTime**, **ShavingEndTime** and **PeakLimits**. **DisChgPeriod1** can be regarded as Peak shaving period. This period should be set to cover load peaks. Battery will be discharged to shave load peak until battery SOC drops to Min SOC (10% by default).

- » **PeakLimits1:** Default: 0 W, range: 0-60000 W

Once the consumption (from the grid) reaches this value, the inverter will start shaving to keep the consumption lower than this value.

- » **ShavingStartTime:** Default: 7:00

The battery starts discharging to shave consumption from the setting time.

- » **ShavingEndTime:** Default: 15:00

The battery stops discharging at the setting time.



- **DisChgPeriod2:** Same working logic with DisChgPeriod1

- » **PeakLimits2:** Default: 0 W, range: 0-60000 W

- » **ShavingStartTime:** Default: 19:00

The battery starts discharging to shave consumption from the setting time.

- » **ShavingEndTime:** Default: 23:00

The battery stops discharging at the setting time.

- **ChargeFromGrid:** It can be used in a specific time period. This period allows the inverter to take energy from grid to charge battery in order to have enough backup for peak shaving. Please note that this period starts from ShavingEndTime2 and ends in ShavingStartTime1.

- » **Enable:** Activate the function of **ChargeFromGrid** to allow the inverter to take energy from the grid to charge the battery. The **ChargePowerLimits** and **MAX_SOC** will be displayed only when **ChargeFromGrid** is enabled.

- » **ChargePowerLimits:** Default: 1000 W; range: 0-60000 W

The limit of power of battery taking power from the grid and charging itself.

- » **MAX_SOC:** Default: 50%; range: 10%-100%

The inverter takes energy from the grid to charge the battery until the battery SOC reaches this value.



- **Reserved_SOC**: Default: 50%; range: 10%-100%
 - » It can be used in a specific time period. In this period, the inverter does not allow "taking grid energy to charge the battery". The PV is the only and first way to charge the battery. To save enough energy for later shaving period, the inverter will not supply power to loads until the battery SOC is higher than the **Reserved_SOC**.



TOU Mode

Different from the other work modes, TOU mode is selected through the LCD but set at the SolaXCloud (App or web). In this mode, you can set different working modes for different time periods in a day. Working modes available for each time period are: Self use mode, battery off, peak shaving mode, charging mode, and discharging mode. For details about how to set the TOU Mode, refer to the document on the SolaXCloud.

Setting User Password

The default password is "0 0 0 0". You can re-set the password here.

10.7.2 Advanced Settings

Setting path: **Menu>Setting>Advanced Settings**

NOTICE!

- All the adjustable parameters including safety code, grid parameter, export control, etc. can be modified under the permissions of installer password. Unauthorized use of the installer password by unauthorized persons can lead to incorrect parameters being inputted, resulting in power generation loss or violation of local regulation. Get the installer password from the dealer and never open the password to unauthorized person.

On-grid Settings

Setting Safety Code

NOTICE!

- The inverter cannot be connected to the grid before the safety code is correctly set. If there is any problem about the safety code of where the inverter installed, please consult your dealer or SolaX service for details.
- The setting varies with different safety codes.

Here you can set the safety code according to different countries and grid-tied standards. In addition, the inverter has an **User Defined** option which allows you to customize relevant parameters with a wider range.

The content displayed by the LCD is subject to the actual situations.

Table 10-3 Safety code

Safety code	Country
TOR	Austria
G99	United Kingdom
TR	Denmark
EN50549-EE	Estonia
EN50549-SE	Sweden
AS 4777.2	Australia
CEI0-21	Italy
C10/26	Belgium
G100 NI	Northern Ireland

Operation on LCD

Safety code	Country
VDE4105	Germany
PEA	Thailand

For Australia, select Australia Region A / B / C in compliance with AS/NZS 4777.2. Only after the safety code setting is completed, some designated parameters in the inverter system will take effect according to the corresponding safety regulations.

Table 10-4 Region settings

Region	Australia A	Australia B	Australia C	New Zealand	
Standard Code Name	AS4777_2020_A	AS4777_2020_B	AS4777_2020_C	New Zealand	Setting Range
OV-G-V	265 V	265 V	265 V	265 V	230-300 V
OV-GV1-T	1.5 s	1.5 s	1.5 s	1.5 s	
OV-G-V2	275 V	275 V	275 V	275 V	230-300 V
OV-GV2-T	0.1 s	0.1 s	0.1 s	0.1 s	
UN-G-V1	180 V	180 V	180 V	180 V	40-230 V
UNGV1-T	10 s	10 s	10 s	10 s	
UN-G-V2	70 V	70 V	70 V	70 V	40-230 V
UNGV2-T	1.5 s	1.5 s	1.5 s	1.5 s	
OV-G-F1	52 Hz	52 Hz	55 Hz	55 Hz	50-55 Hz
OVSF1-T	0.1 s	0.1 s	0.1 s	0.1 s	
OV-G-F2	52 Hz	52 Hz	55 Hz	55 Hz	50-55 Hz
OVSF2-T	0.1 s	0.1 s	0.1 s	0.1 s	
UN-G-F1	47 Hz	47 Hz	45 Hz	45 Hz	40-50 Hz
UNGF1-T	1.5 s	1.5 s	5 s	1.5 s	
UN-G-F2	47 Hz	47 Hz	45 Hz	45 Hz	45-50 Hz
UNGF2-T	1.5 s	1.5 s	5 s	1.5 s	
Startup-T	60 s	60 s	60 s	60 s	15-1000 s
Restore-T	60 s	60 s	60 s	60 s	15-600 s
Recover-VH	253 V	253 V	253 V	253 V	
Recover-VL	205 V	205 V	205 V	198 V	

Region	Australia A	Australia B	Australia C	New Zealand	
Standard Code Name	AS4777_2020_A	AS4777_2020_B	AS4777_2020_C	New Zealand	Setting Range
Recover-FH	50.15 Hz	50.15 Hz	50.15 Hz	50.15 Hz	
Recover-FL	47.5 Hz	47.5 Hz	47.5 Hz	47.5 Hz	
Start-VH	253 V	253 V	253 V	253 V	
Start-VL	205 V	205 V	205 V	198 V	
Start-FH	50.15 Hz	50.15 Hz	50.15 Hz	50.15 Hz	
Start-FL	47.5 Hz	47.5 Hz	47.5 Hz	47.5 Hz	

Setting Main Breaker Limit

Due to power limit, the current of Meter or CT must be set according to the utility's requirements. Failure to set it may cause a circuit breaker fault of the main switchboard, thereby affecting charging and discharging of a battery.

The default value is 250 A, range: 1-250 A

```

==Main Breaker Limit==
>Current      250 A
    
```

Setting Export Control

This function allows the inverter to control the output power to the grid. The setting range for **User Value** is 0-300000. If you do not want to feed power to the grid, set **User Value** to 0.

```

====Export Control====
User Value
                300000W
    
```

NOTICE!

- Under Safety Code AS4777.2, **Export Control** is in the path of **Advanced Settings>On-grid Settings-AS4777 Setting**. You can set the **Soft Limit** and **Hard Limit** of **Export Control** to control the power output to grid. Please refer to "[Setting AS4777](#)" for details.

Setting Phase Unbalanced

This function controls distribution of AC output power. By default, the function is disabled.

- **Enable:** Each phase of power will be independently output according to the corresponding load connected with each phase.

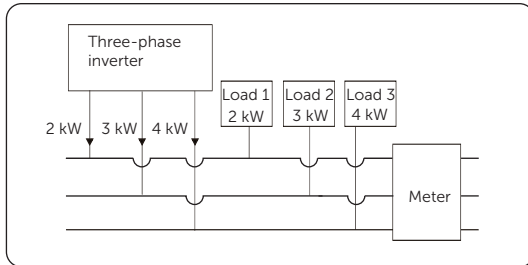

Figure 10-2 Phase Unbalanced enabled

- **Disable:** Three-phase power balanced output, with equal power in each phase. The total power output is determined by the total load power of the three phases.

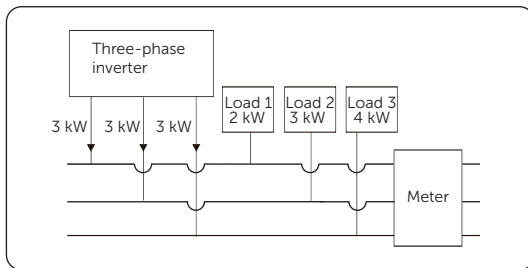
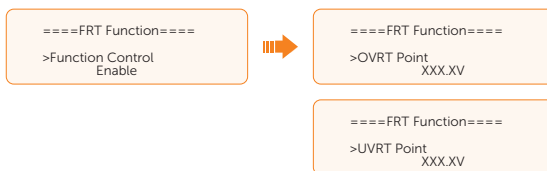

Figure 10-3 Phase Unbalanced disabled

Setting FRT function

FRT (Fault Ride Through) consists of HVRT (High Voltage Ride Through) and LVRT (Low Voltage Ride Through). With the FRT function, the inverter can run constantly without disconnecting from the grid when a fault occurs.

- **Enable:** Enable the FRT function.
- **OVRT Point:** The value for high voltage ride through. Default value: 276.0 V. Settable range: 110.0-300.0 V.
- **UVRT Point:** The value for low voltage ride through. Default value: 115.0 V. Settable range: 4.0-300.0 V.



Setting ripple control

To adjust the feed-in power of the PV modules, you need to use an RCR (Ripple Control Receiver) and enable the ripple control function for the inverter.

At the inverter, one port is reused for two functions: ripple control and DRM. You can only select one of them according to your needs.

The ripple function is disabled by default.

```
====Ripple Control====
>Function Control
  Enable/Disable
```

Setting DRM function (Applicable to AS/NZS 4777.2)

DRM (Demand Response Management) is a demand response method required by the AS/NZS 4777.2 standard and is only applicable to Australia and New Zealand.

At the inverter, one port is reused for two functions: ripple control and DRM. You can only select one of them according to your needs.

The function is enabled by default.

```
====DRM Function====
>Func Select
  Enable
```

Setting Grid parameters

The default value is the specified value under the current safety regulations. The content will be displayed according to the requirements of the local laws and regulations. The content displayed at the LCD is subject to the actual situations.

```
====Grid Parameters====
>Over Volt_L1
  Under Volt_L1
  Over Freq_L1
```

The following table provides you the setting range for each parameter:

Table 10-5 Setting range for parameters

Item	Setting range
Over Volt_L1	110.0-300.0 V
Under Volt_L1	8.0-230.0 V
Over Freq_L1	50.00-70.00 Hz
Under Freq_L1	40.00-60.00 Hz
Over Volt_10min	110.0-300.0 V

Operation on LCD

Item	Setting range
Over Volt_L2	110.0-312.0 V
Under Volt_L2	2.0-230.0 V
Over Freq_L2	50.00-70.00 Hz
Under Freq_L2	40.00-60.00 Hz
OvpTime_L1	
UvpTime_L1	0-100.00s
OfpTime_L1	
UfpTime_L1	
OvpTime_L2	
UvpTime_L2	0-20.00s
OfpTime_L2	
UfpTime_L2	
ReconnectionTime	1-1000s
ConnectionTime	
Connect Slope	1.00-600.00%
Reconnect Slope	
Connection/Reconnection	Lower Frequency: 40.00-50.00 Hz
	Upper Frequency: 50.00-55.00 Hz
	Lower Voltage: 9.0-230.0 V
	Upper Voltage: 11.0-300.0 V
	Observation Time: 10-600s
	Power Gradient: 1.00-600.00%

Setting OFPL

When the output frequency of an inverter exceeds the specified maximum value, the inverter will automatically lower the output frequency, to avoid damages to the device and occurrence of accidents.

OFPL (Over Frequency Power Limit) is lowering the output frequency of an inverter, to control the output power. The following are parameter related to OFPL. The setting items may vary with the local safety regulations and requirements. The displayed content is

subject to the actual situations.

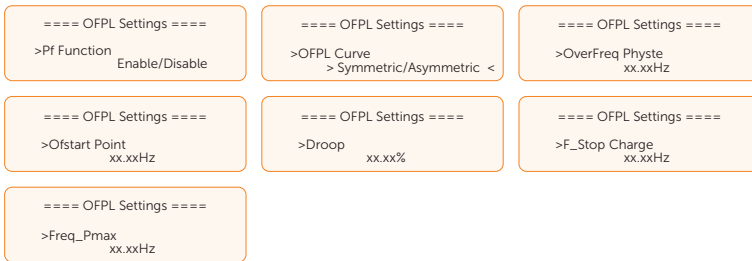

Table 10-7 Setting range for parameters

Item	Setting range
Over Freq Physte	50.00-52.00 Hz
Ofstart Point	50.00-52.00 Hz
Droop	2.0-12.0%
Delay time	0-10.0s
W (Gra)	1.00-600.00
Power Delay Time	0-600s
F_stop Charge	50.00-52.00 Hz
Fre_Pmin	51.00-53.00 Hz

Setting UFPL

If the output frequency of an inverter is lower than the specified maximum value, the inverter will automatically improve the output frequency, to ensure constant output.

UFPL (Under Frequency Power Limit) is improving the output frequency of an inverter, to ensure the ouput power. The following are parameter related to UFPL. The setting items may vary with the local safety regulations and requirements. The content displayed is subject to the actual situations.

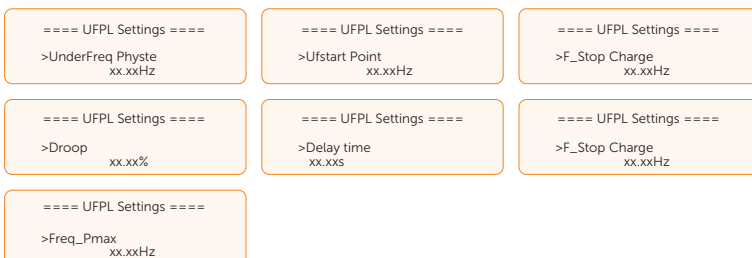

Table 10-8 Setting range for parameters

Item	Setting range
Ufstart Point	46.00-50.00 Hz
Droop	0-100.0%
Delay time	0-10.0s
F_stop Charge	48.00-50.00 Hz
Fre_Pmin	46.00-50.00 Hz

Setting Power Factor

The default value is the specified value under the current safety regulations. The content will be displayed according to the requirements of local laws and regulations. Please refer to the local grid requirements.

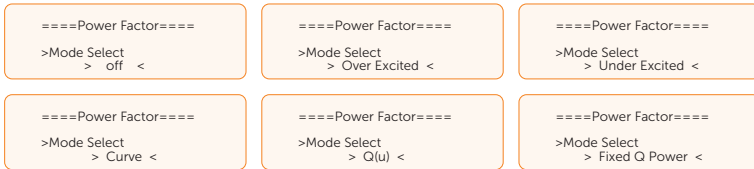

Table 10-9 Items under Power Factor

Item	Composition
Off	
Over Excited	PF Value
Under Excited	PF Value

Item	Composition	
Curve	P1 PF	
	P2 PF	
	P3 PF	
	P4 PF	
	Power 1	
	Power 2	
	Power 3	
	Power 4	
	PflockInPoint	
	PflockOutPoint	
	3Tua	
	Q(u)	SetQuPower1
		SetQuPower2
SetQuPower3		
SetQuPower4		
QuRespondV1		
QuRespondV2		
QuRespondV3		
QuRespondV4		
K		
3Tua		
QuDelayTimer		
QuLockEn		
Fixed Q Power	Q Power	

- Reactive power control, reactive power standard curve $\cos \varphi = f(P)$
 - » For VDE ARN 4105, the curve $\cos \varphi = f(P)$ should refer to curve A. The set default value is shown in curve A.

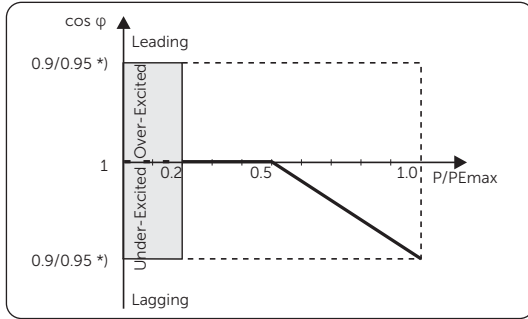

Figure 10-4 Curve A

*) If the Pmax of the inverter \leq 4.6 kW, the Power Factor is 0.95 at 1.0 power; if the Pmax of the inverter $>$ 4.6 kW, the Power Factor is 0.90 at 1.0 power.

- » For CEI 0-21, the default value of PFLockInPoint is 1.05. When $V_{ac} > 1.05V_n$, $P_{ac} > 0.2 P_n$, curve $\cos \phi = f(P)$ corresponds to curve B.

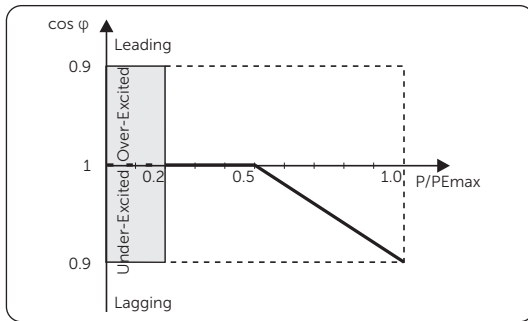

Figure 10-5 Curve B

- Reactive power control, reactive power standard curve $Q = f(V)$

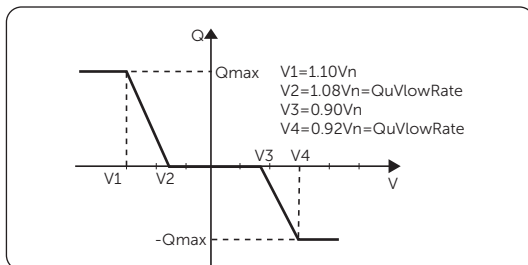

Figure 10-6 Curve $Q = f(V)$

Setting Pu Function

The Pu function is a volt-watt response mode required by certain national standards such as AS/NZS 4777.2. This function can control the active power of the inverter according to the grid voltage. You can set **Response Voltage**, **3Tau**, **PuPower**, **3Tau_Charge** and **Pu Type**.

The items in the **P(u) Function** interface must be adjusted in accordance with the local safety requirements and law regulations, and casual modification is prohibited. For specific settings, please refer to the local grid requirements.

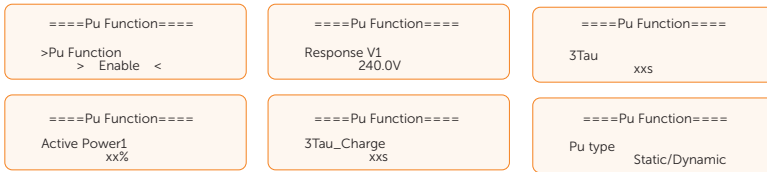

Table 10-10 Setting range for parameters

Item	Setting range
Response V1	240-2760 (precision 0.1 V)
Response V2	
Response V3	
Response V4	
Active power	0-100%
3Tau	0-180s
3Tau Charger	

The following is an example curve for the volt-watt mode.

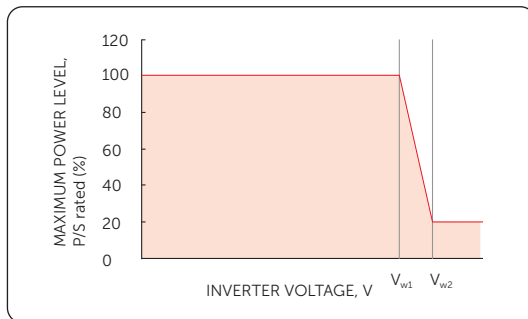

Figure 10-7 Curve for P(u)

Setting Pgrid Bias

This function is to slightly adjust the power of the inverter and the grid side when there is no output in grid-connected state. It is disabled by default.

You can do as follows:

- a. Check the **Meter/CT** value by selecting **Menu>System Status>Meter/CT**.
- b. Select **Menu>Settings>Advanced Settings>Pgrid Bias**.
 - » If the value for **Meter/CT** is negative, select **Grid** for **Pgrid Bias** to discharge power to the mains.
 - » If the value for **Meter/CT** is positive, select **INV** for **Pgrid Bias** to take power from the mains.

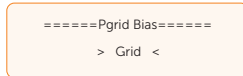

- c. Set the power for the inverter. The default value is 40W. The settable range is 1-500W.

Setting AS4777

The function of **AS4777 Setting** is only activated when the **Safety Code** is set to AS4777 and New Zealand, which is only applicable to Australia and New Zealand.

- a. Select **AS4777 Setting** from **Advanced Settings**. You will see **Export Control** (for active power output control) and **General Control** (for apparent power output control).

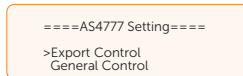

- b. Set the **Soft Limit** value and **Hard Limit** value for Export Control and General Control. The figure below will take the setup of Export Control as an example.

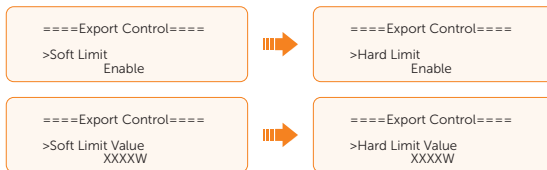

NOTICE!

- **Soft Limit:** Control the output value within the set **Soft Limit Value**.
- **Hard Limit:** If the actual output value reaches the set **Hard Limit Value**, the system will automatically disconnect from the grid and prompt error message on the LCD.

EPS Settings

Select and enter **EPS Setting** interface and set **Frequency**, **Min SOC**, **Min ESC SOC** and **Super Backup**.

- **Frequency:** Default: 50 Hz. Output frequency of EPS
- **Min SOC:** Default: 10%, range: 10%-100%
 - » If the battery SOC is lower than the **Min SOC**, the inverter will prompt **BatPowerLow** and turn off if there is no PV input.
- **Min ESC SoC:** Default: 30%, range: 15%-100%
 - » In EPS mode, the minimum SOC required for re-entry EPS mode after **BatPowerLow** prompted. When the battery SOC reaches the **Min ESC SOC** through charging from PV, the inverter will automatically enter EPS mode from EPS Waiting mode.
- **Super Backup:** This function is disabled by default. When an inverter is in EPS mode and no battery is successfully connected to the inverter, you need to enable the function.

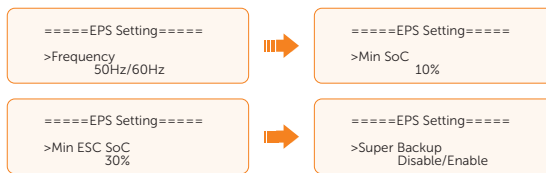

NOTICE!

- In **Super Backup**, loads acquire energy from PVs, which are instable and single-phase. When a user increases or decreases the loads, the system probably reports an error of **Bus Volt Fault** or **Over Load Fault**, which is a common phenomenon and should be neglected.

Battery Settings

Setting Charge

The inverter is compatible with lithium-ion battery. You can set the charge & discharge parameters of battery.

- **Max Charge:** Maximum charging current of battery
- **Max Discharge:** Maximum discharging current of battery
- **Charger upper limit:** The maximum charging limit. Default: 100%, range: 10%-100%.

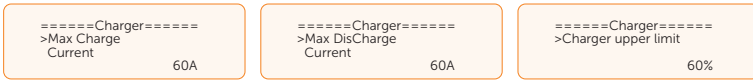

Setting battery heating

This function is disabled by default and is only valid when the battery has the heating function. When **Battery Heating** is enabled, you need to further set the heating period.

- a. Enable the **Battery Heating** function.

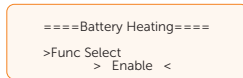

- b. Set the heating start time and end time for the battery. Two heating periods can be set at most.

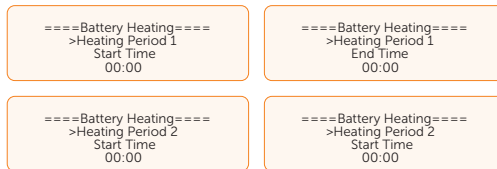

NOTICE!

- If the ambient temperature is extremely low, the battery heating function will consume a large amount of electrical energy.

Setting battery expansion

This function is to expand the capacity of the battery, such as adding a new battery module to an existing system. It is only applicable and functional in on-grid mode. In on-grid mode, enabling this function will make the inverter to charge or discharge the battery SOC to approximately 38%. After this function has been enabled for 48 hours, it will be automatically switched to **Disable**.

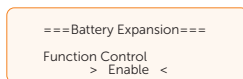

Battery Charge EVC

When the inverter connects to an EV Charger and needs to charge the EVC, you can set as follows:

- a. Select **Menu>Settings>Advanced Settings>Peripheral Settings>Solax485**.

- b. Select **EV Charger**, and set the baud rate and communication address. The baud rate is 9600 by default.

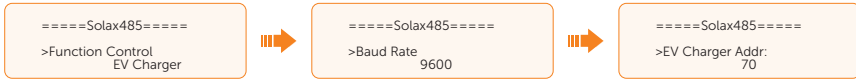

NOTICE!

- When two devices are connected to the inverter at the same time, the baud rate and address of the two devices shall be set to the same.

- c. Check the connecting status of the EV charger.



- d. (optional) Select **Menu>Settings>Advanced Settings>Battery Settings>Battery Charge EVC**, to charge the EVC:

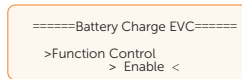

Parallel Settings

If multiple inverters are connected in parallel, you can set the master and slave inverters as follows:

- a. Open the power supply for all inverters. Select an inverter and connect a meter to the inverter. Enter the LCD of the inverter and select **Menu>Settings>Advanced Settings>Parallel Settings**. Set the inverter as **Master** and set **Resistance Switch** to **ON**. If settings succeed, the other inverters automatically become slave inverters.



- b. Find the last slave inverter in the parallel system and set **Resistance Switch** to **ON**.

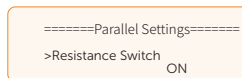

NOTICE!

- For details about parallel connection, refer to “15.6 Application of Parallel Function”.

Peripheral Settings

Setting external generator

There are two methods for switching on/off the external generator: ATS and dry contact. You can refer to the corresponding settings according to the method you selected.

- ATS control

- a. Select **Menu>Settings>Advanced Settings>ExternalGen>ATS Control**.

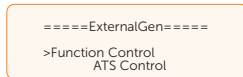

- b. Set the relative parameters as below in accordance with actual needs.

- » **MaxChargePower:** The maximum power of generator charging battery. (0-300000 W, 5000 W by default)

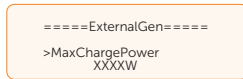

- » **Char&Disc Period:** Including **Forced Charge Period** and **Allowed Disc Period**. Two periods can be set at most.

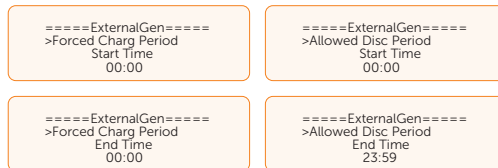

- » **Charge from Gen and Charge battery to:** It allows the battery to take power from the generator. You can set the battery target SOC (10-100%, 10% by default).



- Dry contact control

- a. Select **Menu>Settings>Advanced Settings>ExternalGen>Dry Contact**.

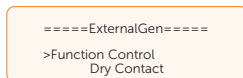

- b. Set the relative parameters in accordance with actual needs.

- » **MaxChargePower:** The maximum power of generator charging battery. (0-300000 W, 5000 W by default).

```

=====ExternalGen=====
>MaxChargePower
5000W
    
```

- » **Start Gen Method:** Two methods for you to select: **Reference SOC** and **Immediately**. **Reference SOC:** Turn on/off the generator according to the set battery SOC. **Immediately:** Turn on /off the generator immediately when the inverter disconnects from the grid.

```

=====ExternalGen=====
>Start Gen Method
Reference soc
    
```

```

=====ExternalGen=====
>Start Gen Method
Immediately
    
```

- » **Switch on/off SOC:** the option is activated when you select **Reference SOC** for **Start Gen Method**. The inverter will turn on the generator when the battery reaches the set **Switch on SOC** and turn it off when the battery reaches the set **Switch off SOC**.

```

=====ExternalGen=====
>Switch on SoC
0%
    
```

```

=====ExternalGen=====
>Switch off SoC
0%
    
```

- » **MaxRunTime:** Maximum operating time of generator. (1000 mins by default)

```

=====ExternalGen=====
>MaxRunTime
1000 Min
    
```

- » **MinRestTime:** Minimum time interval for two consecutive starts to avoid switching on and off frequently. (60 mins by default)

```

=====ExternalGen=====
>MaxRestTime
60Min
    
```

- » **Char&Disc Period:** Including **Forced Charge Period** and **Allowed Disc Period**. Two periods can be set at most.

```

=====ExternalGen=====
>Forced Chrg Period
Start Time
00:00
    
```

```

=====ExternalGen=====
>Allowed Disc Period
Start Time
00:00
    
```

```

=====ExternalGen=====
>Forced Chrg Period
End Time
00:00
    
```

```

=====ExternalGen=====
>Allowed Disc Period
End Time
23:59
    
```

- » **Allow Work:** Allowed time period for generator operating. You can set the start time and end time.

```

=====ExternalGen=====
>Allow Work
Start Time
00:00
    
```

```

=====ExternalGen=====
>Allow Work
End Time
23:59
    
```

- » **Charge from Gen and Charge battery to:** It allows the battery to take power from the generator. You can set the battery target SOC (10-100%, 10% by

default).

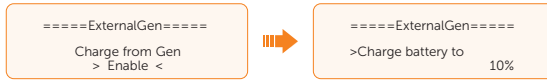

Setting external ATS

The external ATS is used for switchover of the bypass relay.

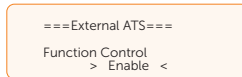

Solax485

Through the function, the inverter can communicate with other SolaX devices, such as EV charger, datahub, and adapter box.

Specific settings are as follows:

- Select **Menu>Settings>Advanced Settings>Peripheral Settings>Solax485**.
- Select a device, for example adapter box. Set the baud rate and communication address. The baud rate is 9600 by default.

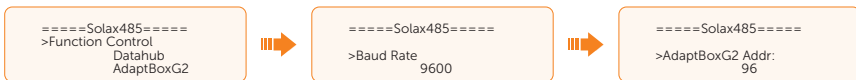

NOTICE!

- When two devices are connected to the inverter at the same time, the baud rate and address of the two devices shall be set to the same.

- Check the connecting status of the device.



Modbus

You can set the address and baud rate for communicating with an external device.



Meter/CT Settings

A CT or electricity meter needs to be connected to the inverter, to monitor the electricity usage. After connecting a meter or CT, you need to set parameters for it in the path of **Advanced Settings > Meter/CT Settings**.

- **Meter setting:** Select **Meter**, and set **Meter 1 Addr** to 1 and **Meter 1 Direction** to **Positive**. Before this setting, you should have set the meter address to 1 on the meter side.

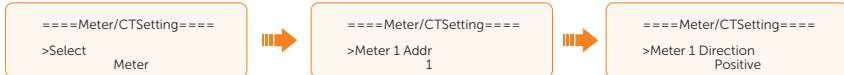

- **CT setting:** Select **CT**, and set **CT type** to 100 A or 200 A according to the actual situations.



Besides, this inverter further provides the check function, to ensure the correct installation and normal operation of meter/CT.

- **Installation check:** Select **Meter/CT Setting > Meter/CT Check**, and then enable **Installation Check**.



The system will perform installation check immediately after you enable it. If the meter or CT is connected properly, the **CT status** will display **Success**, and then automatically restore to **Disable**.

- **Cyclic Check:** Select **Meter/CT Setting > Meter/CT Check**, and then enable **Cyclic Check**.



Once Cyclic Check is enabled, the system will check the meter/CT status periodically based on the defined cycle. If something is wrong with the meter/CT, it will report to the user through the LCD screen or SolaXCloud App.

For more application scenarios, refer to [“15.7 CT/Meter Connection Scenarios”](#).

GMPPT Settings

GMPPT (Global Maximum Power Point Tracking) is to find the maximum points of PV modules and maintain them at the maximum power output. You can set the shadow tracking speed with four options, which are **Off**, **Low**, **Middle**, and **High**. This function is off by default.

- **Off**: Switch off the shadow tracking function.
- **Low**: Scan the shadow every four hours.
- **Middle**: Scan the shadow every three hours.
- **High**: Scan the shadow per hour.

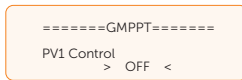

HotStandby Settings

This function is mainly to reduce the energy losses of the system when the power of load is very low.

- **Enable**: When the power of load is very low and other conditions for entering hot standby are met, the inverter will enter **HotStandby** status to reduce system losses.
- **Disabled**: Even when the power of load is very low and other conditions for entering hot standby are met, the inverter still will not enter **HotStandby** status and continue to output power to the load. It is disabled by default.

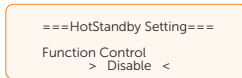

Power Limit Settings

Here you can set the rated output power by percentage.

The percentage of rated output power is used as the actual output power.

Proportion: Default: 1.00; range: 0.00-1.10

For all models of this series inverter, the proportion can be set to 0.00-1.10.

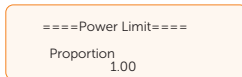

Micro-grid Settings

When a micro grid forms, you need to enable the function.

```

====Micro-grid====
Micro-grid
>Disable<
    
```

Self Test Settings (only for CEI 0-21)

The self test function allows users to test the following items: **Full Test, Ovp (59.S2) test, Uvp (s1) test, Uvp (27. s2) test, Ofp (81> .S1) test, Ufp (81 <.S1) test, Ufp (81> .S2) test, Ufp (81 <.S2) test, Ovp10 (59. s1) test.**

In the **Self Test** interface, the user can select **All Test** or a single test item for testing. All tests take about 6 minutes. And it will display **Success**. For a single test item, it takes about a few seconds or minutes.

Before testing, make sure that the inverter is connected to the grid. Tap **Test Report** to view the test results of all items.

```

=====Self Test=====
>All Test
Test Report
Ovp (59.S2) test
    
```

NOTICE!

- Ovp, Uvp, Ofp, and Ufp are respectively short for over voltage protection, under voltage protection, over frequency protection, and under frequency protection.

Reset

Here you can reset the error log, meter/CT, INV energy and Wi-Fi; and restore to the factory settings.

- Reset Error Log**



- Reset Meter/CT**



- Reset INV Energy**



- Reset Wi-Fi**

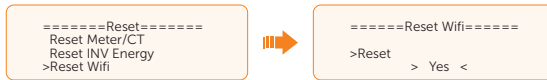

- **Factory Reset**

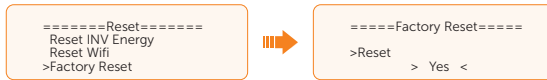

Advanced Password

You can re-set the advanced password here. An installer or distributor may acquire the advanced password from service@solaxpower.com.

10.8 About

Displaying path: **Menu>About**

Here shows the basic information of the inverter, battery and internal code. After entering the **About** interface, you can check those information.

- Inverter
 - » Inverter SN, Register SN, ARM Verion, DSP version, On-grid Runtime, EPS Runtime
- Battery1 and Battery2
 - » BatBrand, Bat_M SN (SN of BMS), Bat_PS1 SN (SN of battery module 1), Bat_PS2 SN (SN of battery module 2), Bat_PS3 SN (SN of battery module 3), Bat_PS4 SN (SN of battery module 4), Battery M Version (software version of BMS) and Battery S version (software version of battery module).
- Internal Code
 - » Internal code of inverter, battery1 and battery2

11 Operation on SolaX App and Web

11.1 Introduction of SolaXCloud

SolaXCloud is an intelligent home energy management platform. It is integrated with energy efficiency monitoring, device management, data communication and other capabilities. While managing your home energy devices, it also helps you optimize the electricity usage efficiency and improve the power generation revenue.

11.2 Operation Guide on SolaXCloud App

11.2.1 Downloading and Installing App

Method 1: Scan the QR code below to download the SolaXCloud App.

The QR code is also available on the lower-right corner of the Web login page of SolaXCloud (www.solaxcloud.com), and the manual of the dongle.



Figure 11-1 QR code

Method 2: Search for **SolaXCloud** in the App Store or Google Play Store, and then download the app.

11.2.2 Operation on the App

After account registration and login, select **Service>Help Center** for text and video operation guidance.

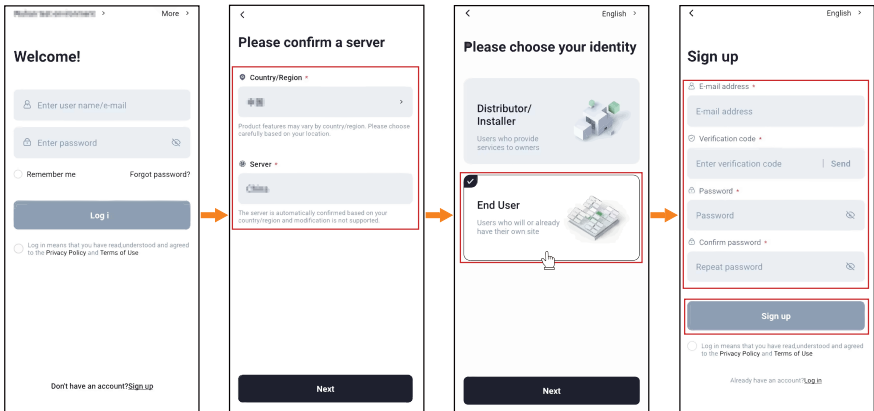

Figure 11-2 Register an account on SolaXCloud App

NOTICE!

- The pages above are from SolaXCloud App V6.0.0, which may change with version upgrade. The finally displayed pages should be subject to the actual situations.

11.3 Operations on SolaXCloud Webpage

Open a browser and enter www.solaxcloud.com and then complete registration, login, site adding and other operations according to the **User Guide**.

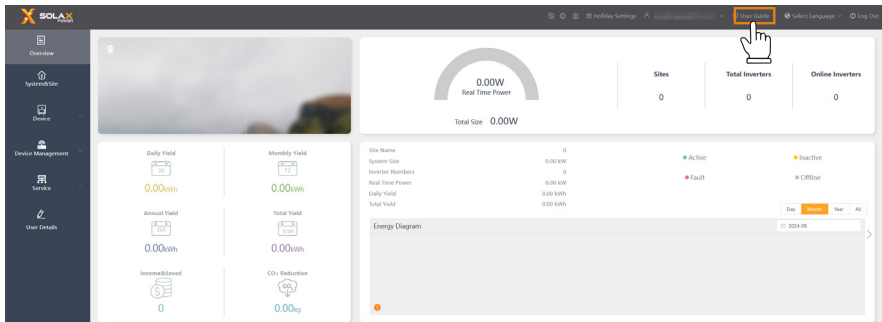

Figure 11-3 User guide on Web

12 Troubleshooting and Maintenance

12.1 Power off

- Turn off the system by **System ON/OFF** on LCD screen.
- Turn off the AC switch between the inverter and the power grid.
- Set the DC switch to **OFF**.
- Switch off the battery or the breaker, button, DC switch of the battery (refer to documentation of the battery manufacturer).

WARNING!

- After the inverter is powered off, there may still be residual electricity and heat which may cause electric shocks and body burns. Please wear personal protective equipment (PPE) and maintain the inverter after power has been cut off for at least 5 minutes.

12.2 Troubleshooting

This section lists the possible problems with the inverter, and provides information and procedures for identifying and resolving them. In case of any errors, check for the warnings or error messages on the system control panel or App, and then refer to the suggestions below. For further assistance, contact SolaX Customer Service. Please provide the model and SN of the inverter, and be prepared to describe the system installation details.

Table 12-1 Troubleshooting list

Error Code	Fault	Diagnosis and Solutions
IE 01	TZ Protect Fault	Overcurrent fault <ul style="list-style-type: none">Wait for a while to check if it returns to normal.Disconnect PV+, PV- and batteries, reconnect.If the system is in off-grid state, check if the power of EPS loads exceeds the maximum limit of the system or exceeds the current power supply of battery.If the system fails to restore to its normal state, contact SolaX for help.
IE 02	Grid Lost Fault	Grid lost fault <ul style="list-style-type: none">Check the grid connection status.Contact SolaX for help.

Error Code	Fault	Diagnosis and Solutions
IE 03	Grid Volt Fault	<p>Power grid voltage overrun</p> <ul style="list-style-type: none"> • Wait a moment, if the utility returns to normal, the system will reconnect. • Please check if the grid voltage is within normal range. • Contact SolaX for help.
IE 04	Grid Freq Fault	<p>Grid overfrequency</p> <ul style="list-style-type: none"> • Wait a moment, if the utility returns to normal, the system reconnects. • Contact SolaX for help.
IE 05	PV Volt Fault	<p>PV overvoltage</p> <ul style="list-style-type: none"> • Check the output voltage of the PV panel. • Check if the DC switch is OFF. • Contact SolaX for help.
IE 06	Bus Volt Fault	<ul style="list-style-type: none"> • Press the ESC key to restart the inverter. • Check if the PV input open circuit voltage is in the normal range. • Check if the power of half-wave load exceeds the system limit. • Contact SolaX for help.
IE 07	Bat Volt Fault	<p>Battery voltage fault</p> <ul style="list-style-type: none"> • Check if the battery input voltage is within normal range. • Contact SolaX for help.
IE 08	AC10mins Volt	<p>Grid voltage out of range in the last 10 minutes</p> <ul style="list-style-type: none"> • The system will return to normal if the grid returns to normal. • Contact SolaX for help.
IE 09	DCI OCP Fault	<p>DCI overcurrent protection fault</p> <ul style="list-style-type: none"> • Wait for a while to check if it's back to normal. • Contact SolaX for help.
IE 10	DCV OVP Fault	<p>DCV EPS (Off-grid) overvoltage protection fault</p> <ul style="list-style-type: none"> • Wait for a while to check if it's back to normal. • Contact SolaX for help.
IE 11	SW OCP Fault	<p>Software detection of overcurrent fault</p> <ul style="list-style-type: none"> • Wait for a while to check if it's back to normal. • Shut down photovoltaic, battery and grid connections. • Contact SolaX for help.

Error Code	Fault	Diagnosis and Solutions
IE 12	RC OCP Fault	Overcurrent protection fault <ul style="list-style-type: none"> • Check the impedance of DC input and AC output. • Wait for a while to check if it's back to normal. • Contact SolaX for help.
IE 13	Isolation Fault	Insulation fault <ul style="list-style-type: none"> • Please check the wire insulation for damage. • Wait for a while to check if it's back to normal. • Contact SolaX for help.
IE 14	Temp Over Fault	Temperature out of range <ul style="list-style-type: none"> • Check if the ambient temperature exceeds the limit. • Contact SolaX for help.
IE 15	Bat Con Dir Fault	Battery direction fault <ul style="list-style-type: none"> • Check if the battery cables are connected in the opposite direction. • Contact SolaX for help if it cannot return to normal.
IE 16	EPS Overload Fault	EPS (Off-grid) overload fault <ul style="list-style-type: none"> • Shutdown the high-power device and press the ESC key to restart the inverter. • Contact SolaX for help if it cannot return to normal.
IE 17	Overload Fault	On-grid mode overload fault <ul style="list-style-type: none"> • Shutdown the high-power device and press the ESC key to restart the inverter. • Contact SolaX for help if it cannot return to normal.
IE 18	BatPowerLow	Bat power low <ul style="list-style-type: none"> • Shutdown the high-power device and press the ESC key to restart the inverter. • Charge the battery to a level higher than the protection capacity or protection voltage.
IE 19	BMS Lost	Battery communication lost <ul style="list-style-type: none"> • Check that the communication cable between the battery and the inverter are properly connected. • Contact SolaX for help if it cannot return to normal.
IE 20	Fan Fault	Fan fault <ul style="list-style-type: none"> • Check for any foreign matter that may have caused the fan not to function properly. • Contact SolaX for help if it cannot return to normal.
IE 21	Low TempFault	Low temperature fault <ul style="list-style-type: none"> • Check if the ambient temperature is too low. • Contact SolaX for help if it cannot return to normal.

Error Code	Fault	Diagnosis and Solutions
IE 25	InterComFault	Internal communication fault <ul style="list-style-type: none"> Restart the inverter. Contact SolaX for help if it cannot return to normal.
IE 26	INV EEPROM	Inverter EEPROM fault <ul style="list-style-type: none"> Shut down photovoltaic, battery and grid, reconnect. Contact SolaX for help if it cannot return to normal.
IE 27	RCD Fault	Residual current device fault <ul style="list-style-type: none"> Check the impedance of DC input and AC output. Disconnect PV+, PV - and batteries, reconnect. Contact SolaX for help if it cannot return to normal.
IE 28	Grid Relay Fault	Electrical relay fault <ul style="list-style-type: none"> Disconnect PV+, PV-, grid and batteries and reconnect. Contact SolaX for help if it cannot return to normal.
IE 29	EPS(Off-grid) Relay Fault	EPS (Off-grid) relay fault <ul style="list-style-type: none"> Disconnect PV+, PV-, grid and batteries and reconnect. Contact SolaX for help if it cannot return to normal.
IE 30	PV ConnDirFault	PV direction fault <ul style="list-style-type: none"> Check if the PV input cables are connected in the opposite direction. Contact SolaX for help if it cannot return to normal.
IE 31	Battery Relay	Charge relay fault <ul style="list-style-type: none"> Press the ESC key to restart the inverter. Contact SolaX for help if it cannot return to normal.
IE 32	Earth Relay	EPS (Off-grid) earth relay fault <ul style="list-style-type: none"> Press the ESC key to restart the inverter. Contact SolaX for help if it cannot return to normal.
IE 33	ParallelFault	Parallel fault <ul style="list-style-type: none"> Check the communication and earth cable connection and matching resistor settings. Contact SolaX for help if it cannot return to normal.
IE 36	HardLimitFault	Hard Limit fault <ul style="list-style-type: none"> Check the power value set in the HardLimit setting, increase the value larger if needed. Contact SolaX for help if it cannot return to normal.
IE 37	CTMeterConFault	CT Meter Con fault <ul style="list-style-type: none"> Check if the CT or meter is well connected. Contact SolaX for help if it cannot return to normal.

Error Code	Fault	Diagnosis and Solutions
IE 40	BypassRelayFault	<p>Bypass relay fault</p> <ul style="list-style-type: none"> • Press the ESC key to restart the inverter. • Contact SolaX for help if it cannot return to normal.
IE 41	ArcFault	<p>Arc fault</p> <ul style="list-style-type: none"> • Check whether the cables between the PV modules and the inverter work normally. • Contact SolaX for help if it cannot return to normal.
IE 101	PowerTypeFault	<p>Power type fault</p> <ul style="list-style-type: none"> • Upgrade the software and press the ESC key to restart the inverter. • Contact SolaX for help if it cannot return to normal.
IE 102	Port OC Warning	<p>EPS (Off-grid) port overcurrent fault</p> <ul style="list-style-type: none"> • Check if the EPS (Off-grid) load exceeds the system requirements, and press the ESC key to restart the inverter. • Contact SolaX for help if it cannot return to normal.
IE 103	Mgr EEPROM Fault	<p>Manager EEPROM fault</p> <ul style="list-style-type: none"> • Shut down photovoltaic, battery and grid, and then reconnect. • Contact SolaX for help if it cannot return to normal.
IE 105	NTC Sample Invalid	<p>NTC invalid</p> <ul style="list-style-type: none"> • Make sure the NTC is properly connected and the NTC is in good condition. • Confirm that the installation environment is normal. • Contact SolaX for help if it cannot return to normal.
IE 106	Bat Temp Low	<p>Battery temperature low</p> <ul style="list-style-type: none"> • Check the battery installation environment to ensure good heat dissipation. • Check if the battery heat function is enabled on the LCD screen of inverter and the heating time period is correctly set. • Contact SolaX for help if it cannot return to normal.
IE 107	Bat Temp High	<p>Battery temperature high</p> <ul style="list-style-type: none"> • Check the battery installation environment to ensure good heat dissipation. • Contact SolaX for help if it cannot return to normal.

Error Code	Fault	Diagnosis and Solutions
IE 109	Meter Fault	<p>Meter fault</p> <ul style="list-style-type: none"> • Check if the meter is normal and is compatible with the inverter. • Check if the communication cable is normal and properly connected. • Check if the communication settings such as protocol, address and baud rate of the meter are consistent with those of the inverter. • Contact SolaX for help if it cannot return to normal.
IE 110	BypassRelayFlt	<p>Bypass relay fault</p> <ul style="list-style-type: none"> • Press the ESC key to restart the inverter. • Contact SolaX for help if it cannot return to normal.
IE 111	ARMParaComFlt	<p>ARM parameter communication fault</p> <ul style="list-style-type: none"> • Check that the communication cables of inverters are well connected and the baud rate of COMM setting of inverters are the same. • Contact SolaX for help if it cannot return to normal.
IE 112	FAN1 Fault	<p>FAN1 fault</p> <ul style="list-style-type: none"> • Check if the foreign objects stuck in the fan. • Contact SolaX for help.
IE113	FAN2 Fault	<p>FAN2 fault</p> <ul style="list-style-type: none"> • Check if the foreign objects stuck in the fan. • Contact SolaX for help.
IE108	FAN3 Fault	<p>FAN3 fault</p> <ul style="list-style-type: none"> • Check if the foreign objects stuck in the fan. • Contact SolaX for help.
BE 01	BMS1_Exter_Err BMS2_Exter_Err	<p>Battery error - external communication fault</p> <ul style="list-style-type: none"> • Contact SolaX for help.
BE 02	BMS1_InterErr BMS2_InterErr	<p>Battery error - internal communication fault</p> <ul style="list-style-type: none"> • Contact SolaX for help.
BE 03	BMS1_OverVolt BMS2_OverVolt	<p>Over voltage in battery system</p> <ul style="list-style-type: none"> • Contact SolaX for help.
BE 04	BMS1_LowerVolt BMS2_LowerVolt	<p>Low voltage in battery system</p> <ul style="list-style-type: none"> • Contact SolaX for help.
BE 05	BMS1_ChargeOCP BMS2_ChargeOCP	<p>Battery fault - over charge fault</p> <ul style="list-style-type: none"> • Contact SolaX for help.

Error Code	Fault	Diagnosis and Solutions
BE 06	DischargeOCP1 DischargeOCP2	Battery fault-discharge over current fault <ul style="list-style-type: none"> • Contact SolaX for help.
BE 07	BMS1_TemHigh BMS2_TemHigh	Over temperature in battery system <ul style="list-style-type: none"> • Contact SolaX for help.
BE 08	BMS1_TempLow BMS2_TempLow	Battery temperature sensor malfunction <ul style="list-style-type: none"> • Contact SolaX for help.
BE 09	CellImblance1 CellImblance2	Battery Unbalanced Fault <ul style="list-style-type: none"> • Contact SolaX for help.
BE 10	BMS1_Hardware BMS2_Hardware	Battery hardware protection fault <ul style="list-style-type: none"> • Contact SolaX for help.
BE 11	BMS1_Circuit BMS2_Circuit	Battery circuit fault <ul style="list-style-type: none"> • Restart the battery. • Contact SolaX for help.
BE 12	BMS1_ISO_Fault BMS2_ISO_Fault	Battery insulation fault <ul style="list-style-type: none"> • Check that the battery is properly grounded and restart the battery. • Contact SolaX for help.
BE 13	BMS1_VolSen BMS2_VolSen	Battery voltage sensor fault <ul style="list-style-type: none"> • Contact SolaX for help.
BE 14	BMS1_TempSen BMS2_TempSen	Temperature sensor fault <ul style="list-style-type: none"> • Restart the battery. • Contact SolaX for help.
BE 15	BMS1_CurSen BMS2_CurSen	Battery current sensor fault <ul style="list-style-type: none"> • Contact SolaX for help.
BE 16	BMS1_Relay BMS2_Relay	Battery relay fault <ul style="list-style-type: none"> • Contact SolaX for help.
BE 17	TypeUnmatch1 TypeUnmatch2	Battery type fault <ul style="list-style-type: none"> • Upgrade the battery BMS software. • Contact SolaX for help.
BE 18	Ver Unmatch1 Ver Unmatch2	Battery version mismatch fault <ul style="list-style-type: none"> • Upgrade the battery BMS software. • Contact SolaX for help.

Error Code	Fault	Diagnosis and Solutions
BE 19	MFR Unmatch1	Battery manufacturer mismatch fault <ul style="list-style-type: none"> • Upgrade the battery BMS software. • Contact SolaX for help.
	MFR Unmatch2	
BE 20	SW Unmatch1	Battery hardware and software mismatch fault <ul style="list-style-type: none"> • Upgrade the battery BMS software. • Contact SolaX for help.
	SW Unmatch2	
BE 21	M&S Unmatch1	Battery master slave control mismatch fault <ul style="list-style-type: none"> • Upgrade the battery BMS software. • Contact SolaX for help.
	M&S Unmatch2	
BE 22	CR NORespond1	Battery charging request no respond <ul style="list-style-type: none"> • Upgrade the battery BMS software. • Contact SolaX for help.
	CR NORespond2	
BE 23	BMS1 SW Protect	Battery slave software protection failure <ul style="list-style-type: none"> • Upgrade the battery BMS software. • Contact SolaX for help.
	BMS2 SW Protect	
BE 24	BMS1 536 Fault	Battery discharge over current fault <ul style="list-style-type: none"> • Contact SolaX for help.
	BMS2 536 Fault	
BE 25	BMS1 SelfCheck	Over temperature in battery system <ul style="list-style-type: none"> • Contact SolaX for help.
	BMS2 SelfCheck	
BE 26	BMS1 Tempdiff	Battery temperature sensor malfunction <ul style="list-style-type: none"> • Contact SolaX for help.
	BMS2 Tempdiff	
BE 27	BMS1_BreakFault	Battery unbalanced fault <ul style="list-style-type: none"> • Contact SolaX for help.
	BMS2_BreakFault	
BE 28	BMS1_FlashFault	Battery hardware protection failure <ul style="list-style-type: none"> • Contact SolaX for help.
	BMS2_FlashFault	
BE 29	BMS1_Precharge	Battery precharge fault <ul style="list-style-type: none"> • Contact SolaX for help.
	BMS2_Precharge	
BE 30	AirSwitchBreaker1	Battery air switch fault <ul style="list-style-type: none"> • Check if the battery breaker is off. • Contact SolaX for help.
	AirSwitchBreaker2	
BE 31	ClusterCntMIS1	Cluster communication loss <ul style="list-style-type: none"> • Check the communication cables for the master control and parallel connection box.
	ClusterCntMIS2	

Error Code	Fault	Diagnosis and Solutions
BE 32	ClusterComAddr1	Cluster address repeated
	ClusterComAddr2	<ul style="list-style-type: none"> • Wait for the system to restore automatically. If the system fails to restore, try to restart the battery.
/	Screen not on	<ul style="list-style-type: none"> • Check if the inverter correctly and normally connected to PV, battery or grid. • Contact SolaX for help if the inverter is connected correctly.
	Abnormal sound on fan	<ul style="list-style-type: none"> • Check if there is foreign objects stuck in the fan. • Contact SolaX for help.
/	Screen on but no content display	<ul style="list-style-type: none"> • Contact SolaX for help.
/	LCD screen stuck in Wait state	<p>Check whether the input voltage of PV is greater than 140 V and the input voltage of battery is greater than 130 V.</p> <ul style="list-style-type: none"> • If it meets the requirement, contact SolaX for help. • If the input voltage of battery or PV is less than the specified value, check the corresponding connection.
/	No readings after CT connection	<ul style="list-style-type: none"> • Check if CT is correctly clipped on the L wire • Check if the arrow on the CT points at Grid. • Contact SolaX for help if it cannot return to normal.
/	No readings on Load (on App or Web)	<ul style="list-style-type: none"> • Check if the load is connected correctly. • Check if the power of load on the LCD screen displays normally. • Check if the monitoring module works normally. • Contact SolaX for help if it cannot return to normal.
/	No readings on Grid (on App or Web)	<ul style="list-style-type: none"> • Check if the grid connection is normal. • Check if the grid parameter on the LCD screen displays normally. • Check if the monitoring module works normally. • Contact SolaX for help if it cannot return to normal.
/	No readings on battery (on App or Web)	<ul style="list-style-type: none"> • Check if the battery is connected correctly. • Check if the battery parameter on the LCD screen displays normally. • Check if the monitoring module works normally. • Contact SolaX for help if it cannot return to normal.
/	No Feedin data (on App or Web)	<ul style="list-style-type: none"> • Check if the meter/CT is connected correctly. • Check if the meter/CT parameter on the LCD screen displays normally. • Check if the monitoring module works normally. • Contact SolaX for help if it cannot return to normal.

Error Code	Fault	Diagnosis and Solutions
/	No data on App or Web	<ul style="list-style-type: none"> • Check if the monitoring module works normally. • Contact SolaX for help.
/	No display on meter after power on	<ul style="list-style-type: none"> • If the meter connection is abnormal, reconnect them according to the wiring diagrams. • Wait for the grid voltage to restore. • Contact SolaX for help if it cannot return to normal.
/	Abnormal electrical data on meter	<ul style="list-style-type: none"> • If the wiring is incorrect, reconnect them based on the wiring diagrams. • Set the voltage and current ratio according to the setting steps of meter user manual. • Contact SolaX for help if it cannot return to normal.

12.3 Maintenance

Regular maintenance is required for the inverter. Please check and maintain the following items based on the instructions below to ensure the optimal performance of the inverter. For inverters working in inferior conditions, more frequent maintenance is required. Please keep maintenance records.



WARNING!

- Only qualified person can perform the maintenance for the inverter.
- Only spare parts and accessories authorized by SolaX can be used for maintenance.

12.3.1 Maintenance Routines

Table 12-2 Proposal of Maintenance

Item	Check notes	Maintenance interval
Fans	<ul style="list-style-type: none"> • Check if the fan makes noise or is covered by dust. • Clean the fan with a soft and dry cloth or brush, or replace the fan if necessary. 	Every 12 months
Electrical connection	<ul style="list-style-type: none"> • Ensure that all cables are firmly connected. • Check the integrity of the cables, ensuring that there are no scratches on the parts touching the metallic surface. • Verify that the sealing caps on idle terminals are not falling off. 	Every 12 months
Grounding reliability	<ul style="list-style-type: none"> • Check if the grounding cables are firmly connected to the grounding terminals. Use a ground resistance tester to test the grounding resistance from the inverter enclosure to the PE bar in the power distribution box. 	Every 12 months
Heat sink	<ul style="list-style-type: none"> • Check if there are foreign objects in the heat sink. 	Every 12 months
General status of inverter	<ul style="list-style-type: none"> • Check if there is any damage on the inverter. • Check if there is any abnormal sound when the inverter is running. 	Every 6 months

If the fan is broken, you can replace it in the following steps:

- Step 1:** Remove cables and connectors for the Grid&EPS port, MPPT port, BAT/V2X port and grounding point with the corresponding tools. Take down the anti-theft lock (if any).

NOTICE!

- For details about disassembling the inverter, please refer to “13 Decommissioning”.

Step 2: Take the inverter down from the wall and slightly put it on a foam cushion with the back surface upforward. Remove 4 fastening screws from the back of the device with a cross screwdriver and unplug the connection cables from the fan.

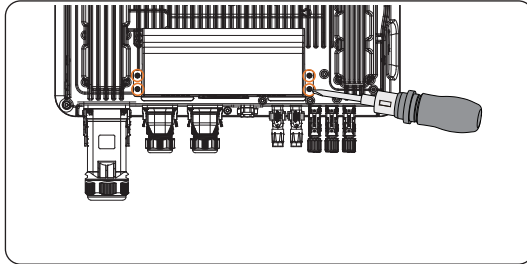

Step 3: Remove 4 screws on the fan cover with a cross screwdriver and take the fan cover down.

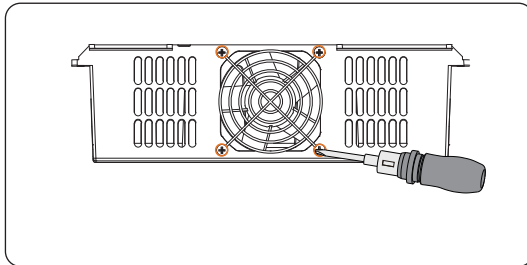

Step 4: Replace with a new fan (pay attention to the installation direction of the fan) and fasten the screws for the fan.

Step 5: Replug the cables to the fan and put the fan cover back.

Step 6: Hang the inverter onto the wall and connect the connectors and cables to the Grid&EPS port, MPPT port, BAT/V2X port and grounding point.

12.3.2 Upgrading Firmware

 **WARNING!**

- Make sure that the type and format of the firmware file are correct. Do not modify the file name. Otherwise, the inverter may not work properly.
- Do not modify the folder name and file path where the firmware files are located, as this may cause the upgrade to fail.

 **WARNING!**

- Before upgrading, ensure that the PV input voltage is higher than 180 V (preferably on sunny day), or that the battery SOC is higher than 20%, or the battery input voltage is higher than 180 V. Failure to meet one of these conditions may result in upgrade process failure.

Upgrade preparation

- Prepare a USB drive (USB 2.0/3.0, ≤32 GB, FAT 16/32).
- Check for the current firmware version of the inverter.
- Contact our service support for the update firmware file, and save it to the USB drive.
 - » For ARM file: XXX.XXXXX.XX_HYB_3P_ARM_PRO_VXXX.XX_XXXX.usb
 - » For DSP file: XXX.XXXXX.XX_HYB_3P_DSP_PRO_VXXX.XX_XXXX.usb
- Check the folder name and file path:

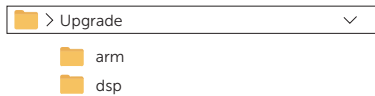
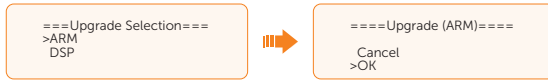

Figure 12-4 Folder name and path

Upgrade steps

- a. Press and hold the **Enter** key on the inverter LCD for 5 seconds to enter the **OFF** mode.
- b. Remove the dongle from the Dongle port of the inverter by hand, and then insert the USB drive. The inverter will automatically display the **Upgrade Selection** interface. (For the position of Dongle port, refer to “[8.1.1 Ports and Parts of Inverter](#)”.)
- c. On the **Upgrade Selection** interface, select **ARM** or **DSP** based on the file type, and then tap **OK**.



- d. Select and confirm the firmware version, and then tap the **Enter** key to start updating. ARM update takes about 20 seconds, and DSP update takes about 2 minutes.

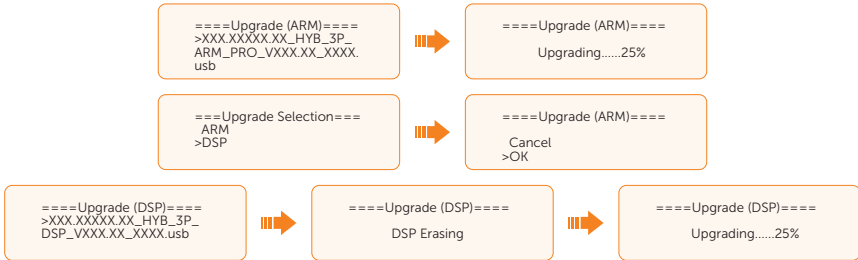

- e. After the upgrade is completed, the LCD screen displays **Upgrade Successful**. If the upgrade fails, the LCD screen displays **Upgrade failed**.

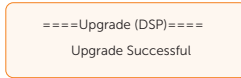

 **CAUTION!**

- If the ARM firmware upgrade fails or stops, do not unplug the USB drive. Power off the inverter, restart it, and then repeat the above upgrade steps.

 **CAUTION!**

If the DSP firmware upgrade fails or stops, perform operations below to troubleshoot:

- Check if the DC switch is turned off. If it is off, turn it on.
- (Recommended) If the DC switch is already on, check if the battery and PV parameters in **Menu>System Status** meets the upgrade requirements (The PV or battery input voltage should be larger than 180 V, or the battery SOC be higher than 20%).
- Alternatively, select **Menu>Mode Select>Manual>Forced Charge** to charge the battery. This process can help wake up the battery for DSP upgrade.

NOTICE!

- If the LCD screen lags or freezes after the upgrade, turn off the DC switch, and then restart the inverter. Check if the inverter returns to normal. If not, contact us.

13 Decommissioning

13.1 Disassembling the Inverter



- Strictly follow the steps below to disassemble the inverter.
- Only use the dedicated removal tool delivered with the inverter to disassemble the AC connector, PV connector, battery connector and communication connector.

Step 1: Turn off the system through the LCD.

Step 2: Disconnect the external AC breaker of the inverter.

Step 3: Rotate the DC switch to OFF.

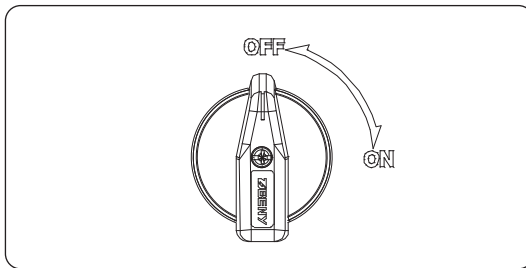

Figure 13-1 Switching off

Step 4: Turn off the battery switch / button / breaker (if any). (Refer to documents of battery)

Step 5: Disconnect the PV connectors: Insert the dedicated PV removal tool into the notch of PV connectors and slightly pull out the connectors.

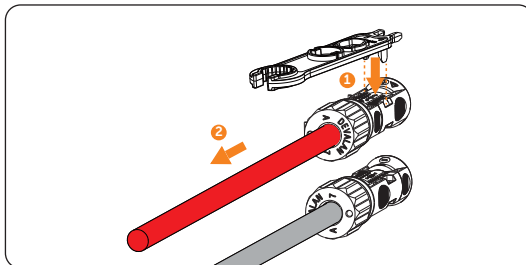

Figure 13-2 Disconnecting the PV connector

Step 6: Slightly pull out the dongle module.

Step 7: Disconnect the battery connectors: Insert a flat screwdriver into the notch of connectors and slightly pull out the connectors.

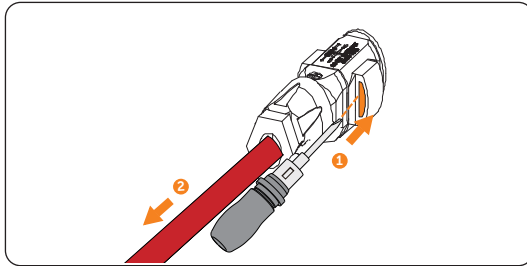

Figure 13-3 Disconnecting the battery connector

Step 8: Disconnect the AC connector: Loosen the screw on the latch with an Allen key, pull the latch up to 45°, and slightly pull the connector out.

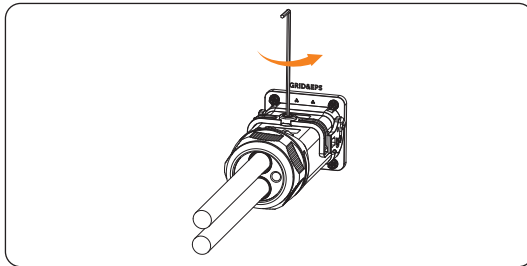

Figure 13-4 Loosening the screw

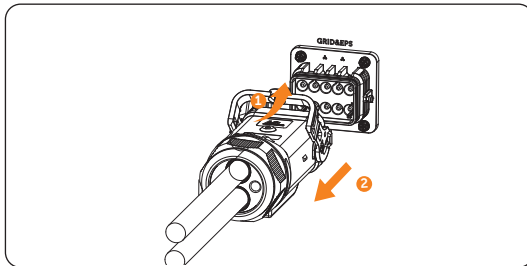

Figure 13-5 Pulling the latch up and pulling the connector out

Step 9: Disconnect the COM 1 connector and COM 2 connector: Loosen the screw of the COM connector and anti-clockwise loosen M3 screw of the communication connector by a cross screwdriver. Pinch latches on both sides of the connector enclosure with one hand and pull the connector with the other hand until communication cables inside it are exposed. Unplug the communication cables from the COM 1 or COM 2 port (with a flat screwdriver if needed). Remove all

cables from the connector. Put the sealing plug and cable support sleeve to the original positions, fasten the swivel nut, connect the connector to the device and tighten the screw on the connector.

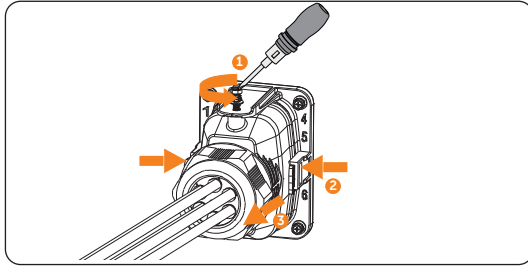

Figure 13-6 Disconnecting the communication connector

Step 10: Put the original ports caps back to the ports.

Step 11: Unscrew the grounding screw with an Allen key and remove the grounding cable.

Step 12: (Optional) Unlock the anti-theft lock if you installed it.

Step 13: Unscrew the M5 screw on the left side of the inverter and vertically lift up the inverter to dismantle the inverter.

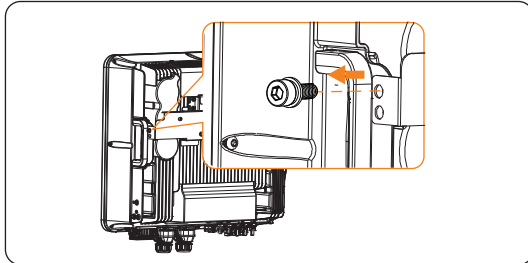

Figure 13-7 Removing the M5 screw

Step 14: Unscrew the screw for fastening the wall mounting bracket and remove the wall mounting bracket if needed.

13.2 Packing the Inverter

- Use the original packaging materials if available.

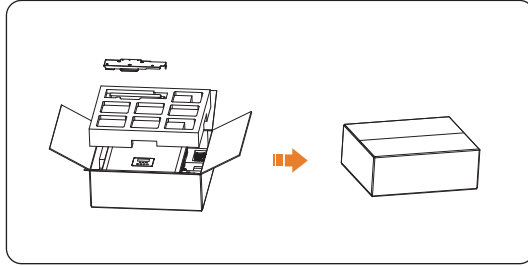

Figure 13-8 Packing the inverter

- If the original packing material is not available, use the packing material which meets the following requirements:
 - » Suitable for the weight and dimension of product
 - » Convenient for transportation
 - » Can be sealed with adhesive tape

13.3 Disposing of the Inverter

Properly dispose of the inverter and accessories in accordance with local regulations on the disposal of electronic waste.

14 Technical Data

- DC Input

Model	X3-HYB-4.0-P	X3-HYB-5.0-P	X3-HYB-6.0-P	X3-HYB-8.0-P	X3-HYB-10.0-P	X3-HYB-12.0-P	X3-HYB-15.0-P
Max. recommended DC power[W]	8000	10000	12000	16000	20000	24000	30000
Maximum power of each MPPT	The power of each MPPT \leq rated power of the whole machine						
Max. DC voltage [V]	1000						
Normal DC operating voltage [V]	650						
Max. input current (input A/input B/input C/input D) [A]	PV1: 20/PV2: 20			PV1: 20/PV2: 20/PV3: 20			
TA=45 C	PV1: 16/PV2: 16			PV1: 16/PV2: 16/PV3: 16			
Max. short circuit current (input A/input B) [A]	PV1: 25/PV2: 25			PV1: 25/PV2: 25/PV3: 25			
Max. inverter backfeed current to the array	0 d. c. A						
MPPT voltage range [V]	110-950						
MPPT voltage range [V] (full load)	330-800						
Halt	330V 16A*3						
Start input voltage [V] light screen	120						
Start output voltage [V] on-grid	140						
No. of MPP trackers	2			3			
Strings per MPP tracker	PV1: 1/PV2: 1			PV1: 1/PV2: 1/PV3: 1			
DC disconnection switch	Yes						

- AC Output (On-grid)

Model	X3-HYB-4.0-P	X3-HYB-5.0-P	X3-HYB-6.0-P	X3-HYB-8.0-P	X3-HYB-10.0-P	X3-HYB-12.0-P	X3-HYB-15.0-P
Normal AC power [VA]	4000	5000 (4999 for AS 4777)	6000	8000	10000 (9999 for AS 4777)	12000	15000 (14999 for AS 4777)
Max. apparent AC power [VA]	4400	5500 (4999 for AS 4777)	6600	8800	11000 (9999 for AS 4777)	13200	16500 (14999 for AS 4777)
Rated grid voltage (AC voltage range) [V]	400V/380						
Rated grid Frequency [Hz]	50/60						
Normal AC current [A]@230V	5.8	7.2	8.7	11.6	14.5	17.5	21.8
Max. AC current [A]@220V	6.7	8.4	10.0	13.4	16.7	20.0	25.0
Current (inrush)	115 a.c.A (rms)						
Max. output fault current	85 a.c.A (peak)						
Max. output overcurrent protection	88 a.c.A (peak)						
Displacement power factor	~1 (Adjustable from 0.8 leading to 0.8 lagging)						
Total harmonic distortion (THDi, rated power)	<3%						
Parallel operation	Yes						
Load control	Yes						

Technical Data

- AC Input

Model	X3-HYB-4.0-P	X3-HYB-5.0-P	X3-HYB-6.0-P	X3-HYB-8.0-P	X3-HYB-10.0-P	X3-HYB-12.0-P	X3-HYB-15.0-P
Normal AC power[VA]	8000	10000	12000	16000	20000	20000	20000
Normal AC current [A]	11.6	14.5	17.4	23.2	29.0	29.0	29.0
Max. AC current [A]	12.2	15.2	18.2	24.3	30.4	30.4	30.4
Rated grid voltage (AC voltage range) [V]	400V/380V						
Rated grid Frequency[Hz]	50/60						
Power factor	~1 (Adjustable from 0.8 leading to 0.8 lagging)						

- Battery

Model	X3-HYB-4.0-P	X3-HYB-5.0-P	X3-HYB-6.0-P	X3-HYB-8.0-P	X3-HYB-10.0-P	X3-HYB-12.0-P	X3-HYB-15.0-P
Battery voltage range [V]	130-800						
Recommended battery voltage [V]	400 VDC						
Max.charge/ discharge power [W]	1.1 Pn/2 Pn						
Bat 1 Max.charge/ discharge current [A] Bat 2 Max.charge/ discharge current [A]	30 (25*) d. c. A /30 (25*) d. c. A ** indicates that the current when Bat 1 and Bat 2 both work.						
Bat 1 Peak charge/ discharge current [A] Bat 2 Peak charge/ discharge current [A]	30 (25*) d. c. A /30 (25*) d. c. A ** indicates that the current when Bat 1 and Bat 2 both work.						
Communication interfaces	CAN/RS485						
Reverse connection protection	Yes						

- EPS Output

Model	X3-HYB-4.0-P	X3-HYB-5.0-P	X3-HYB-6.0-P	X3-HYB-8.0-P	X3-HYB-10.0-P	X3-HYB-12.0-P	X3-HYB-15.0-P
EPS continual apparent power [VA]	4000	5000	6000	8000	10000	12000	15000
EPS rated voltage[V], Frequency [Hz]	400V/230VAC, 50/60						
EPS rated current [A]	5.8	7.2	8.7	11.6	14.5	17.5	21.8
EPS single-phase overload	Below 10k: 2Pn/3@10s, 50%Pn@ keep on; 12/15k, 5.5 kw@ keep on						
EPS peak power [W]	≤1.1Pn always running; 1.1Pn-2Pn 10s; > 2Pn report errors immediately						
Switch time [ms]	<10 ms						
Total harmonic distortion (THDv, linear Load)	<3%						
Parallel operation	Yes, 10						

- Efficiency, Safety and Protection

Model	X3-HYB-4.0-P	X3-HYB-5.0-P	X3-HYB-6.0-P	X3-HYB-8.0-P	X3-HYB-10.0-P	X3-HYB-12.0-P	X3-HYB-15.0-P
MPPT efficiency	99.90%						
Euro-efficiency	97.70%						
Max. efficiency	98.00%						
Rated battery charge/discharge efficiency	98.5% /97.00%						
Safety	IEC62109-1/IEC62109-2						
Protection class	IP66						

Technical Data

- Power consumption

Model	X3-HYB-4.0-P	X3-HYB-5.0-P	X3-HYB-6.0-P	X3-HYB-8.0-P	X3-HYB-10.0-P	X3-HYB-12.0-P	X3-HYB-15.0-P
Internal consumption (night) [W]	<40W for hot standby, <5W for cold standby						
Idle mode	Yes						

- Standard

Model	X3-HYB-4.0-P	X3-HYB-5.0-P	X3-HYB-6.0-P	X3-HYB-8.0-P	X3-HYB-10.0-P	X3-HYB-12.0-P	X3-HYB-15.0-P
EMC	EN 61000-6-1 / EN 61000-6-2 / EN 61000-6-3						
Certification	VDE 0126-1-1 A1:2012 / VDE-AR-N 4105 /G98/G99/ AS4777 / EN50549/ CEI 0-21						

- Environment limit

Model	X3-HYB-4.0-P	X3-HYB-5.0-P	X3-HYB-6.0-P	X3-HYB-8.0-P	X3-HYB-10.0-P	X3-HYB-12.0-P	X3-HYB-15.0-P
Operating temperature range [°C]	-35°C~60°C (derating at +45°C)						
Humidity [%]	0~100 (condensing)						
Altitude [m]	≤3000						
Storage temperature [°C]	-40°C~65°C						
Noise emission (typical) [dB]	<35			<45			
Over voltage category	III (electric supply side), II (PV side)						

- General paramters

Model	X3-HYB-4.0-P	X3-HYB-5.0-P	X3-HYB-6.0-P	X3-HYB-8.0-P	X3-HYB-10.0-P	X3-HYB-12.0-P	X3-HYB-15.0-P
Cooling concept	Nature Convection, FAN						

Model	X3-HYB-4.0-P	X3-HYB-5.0-P	X3-HYB-6.0-P	X3-HYB-8.0-P	X3-HYB-10.0-P	X3-HYB-12.0-P	X3-HYB-15.0-P
Topology	Non-isolated						
Communication	COM 1 (including ports Meter/CT, RS485, BMS 1, BMS 2, PARA 1, and PARA 2) and COM 2 (including ports DATAHUB, HEATPUMP, EVC, V2X, DI/DO, and DRM)						
LCD display	LCD						
Dimensions [mm] outer frame	560*503*210						
Net weight [kg]	38						

* The specific gross weight is subject to the actual situation of the whole machine.

15 Appendix

15.1 Application of Generator

15.1.1 Introduction of Generator Application

When the utility power supply is unavailable, the system can seamlessly switch to a generator, to form a new energy supply system, thereby ensuring uninterrupted operation of loads.

In this case, the generator functions as the utility grid to supply power to the loads, and the hybrid inverter converts the solar energy to electricity.

15.1.2 Notice for Generator Application

- Note 1: The generator should be equipped with an ATSE, enabling it to start automatically in the event of a power outage.
- Note 2: The rated output power of the generator should be greater than the sum of the load power and the battery charging power. If there are multiple inverters connected in parallel, the rated output power of the generator should be greater than the sum of the load power and the battery charging power of all the inverters.
- Note 3: If the rated output power of the generator is small and cannot meet the requirements of Note 2, the setting value of **MaxChargePower** can be changed by selecting **Menu>Settings>Advanced Settings>Peripheral Settings>ExternalGen**, to ensure that the generator power can meet the total needs of loads and battery charging.
- Note 4: The EPS load power cannot be greater than the battery discharge power to prevent that the battery power cannot meet the requirements of EPS loads after the generator shuts down. Or the inverter will report an **Overload fault** alarm. If two inverters are connected in parallel, the EPS load power shall be doubled.

15.1.3 ATS Control Mode

In this mode, the generator functions as a substitute for the grid. There is no communication between the generator and the inverter, which means no wiring modifications are required (but the inverter cannot control the generator either). The ATS working for the generator determines whether to turn on the generator based on the status of the grid.

Wiring connection diagram

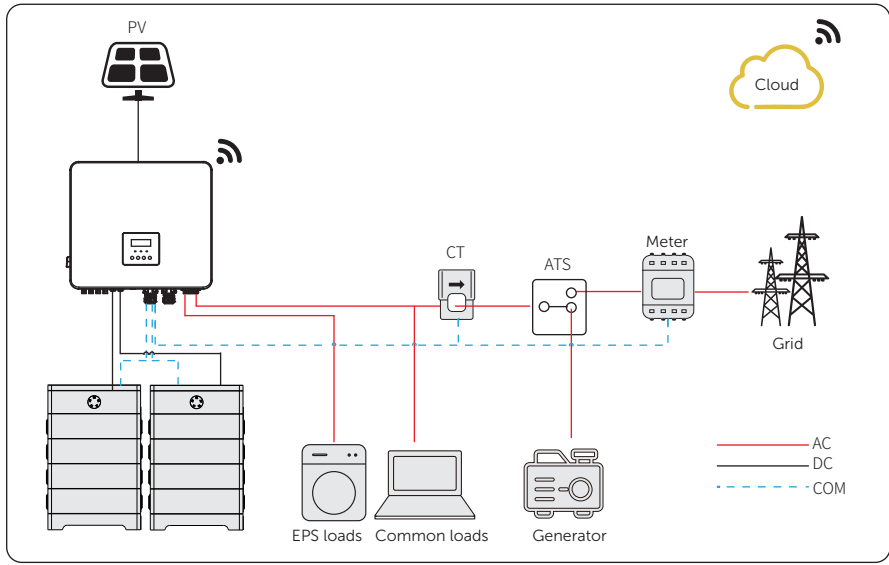

Figure 15-1 ATS control wiring diagram

Inverter settings for ATS control mode

- Select **Menu>Settings>Advanced Settings>ExternalGen>ATS Control**.

```
====ExternalGen====
>Function Control
  ATS Control
```

- Set the relative parameters as below in accordance with actual needs.

- » **MaxChargePower:** The maximum power of generator charging battery. (0-300000 W, 5000 W by default)

```
====ExternalGen====
>MaxChargePower
  XXXXW
```

- » **Char&Disc Period:** Including **Forced Charge Period** and **Allowed Disc Period**. Two periods can be set at most.



- » **Charge from Gen and Charge battery to:** It allows the battery to take power from the generator. You can set the battery target SOC (10-100%, 10% by default).

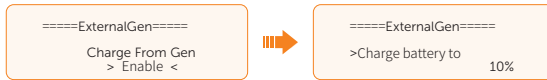

15.1.4 Dry Contact Mode

In this operating mode, users can intelligently control the system by establishing a dry contact connection between the inverter and the generator. It allows for adjustments to multiple settings so that the system can meet the requirements of different scenarios.

Wiring connection diagram

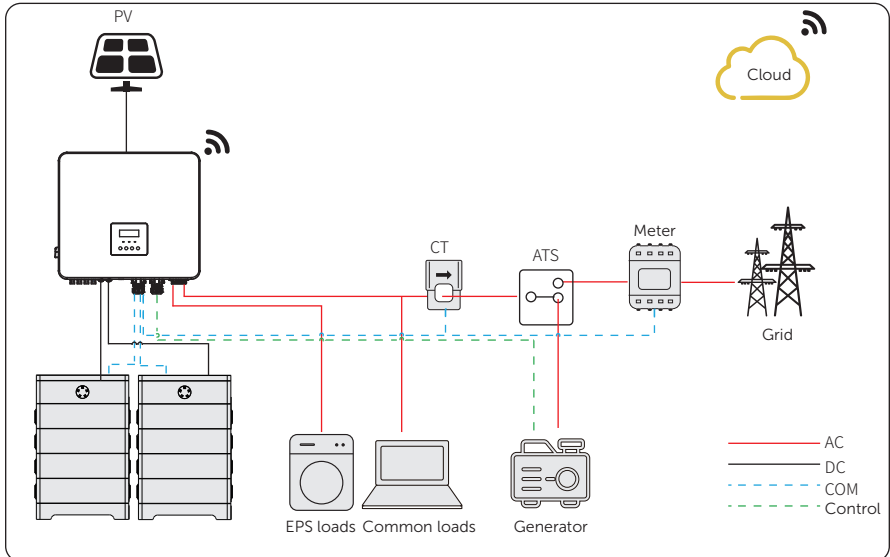

Figure 15-2 Dry contact wiring diagram

Inverter connection for dry contact mode

- Connection port-Support DI/DO in Port COM 2

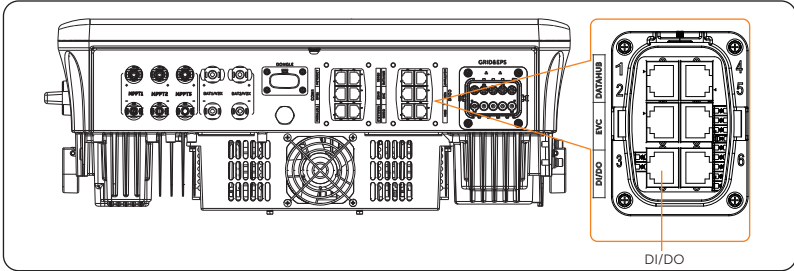

Figure 15-3 Connection port for generator

- Connection pins-Pin 7 and Pin 8 of port DI/DO

Table 15-1 Definition of pins of port DI/DO

Pin	Definition	Description
1	DI1_A	Dry contact for input
2	DI1_B	
3	12V_COM_EXT	/
4	3.3V_COM	System off signal
5	INVERTER_OFF	
6	GND	/
7	DO2_A	Dry contact for output
8	DO2_B	

- Connection steps: Please refer to “8.7.3 DI/DO Communication Connection” for specific wire making and connection.

- Inverter settings for dry contact mode

- Select **Menu>Settings>Advanced Settings>ExternalGen>Dry Contact**.

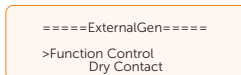

- Set the relative parameters in accordance with actual needs.

- » **MaxChargePower**: The maximum power of generator charging battery. (0-300000 W, 5000 W by default).

```
====ExternalGen====
>MaxChargePower
500W
```

- » **Start Gen Method:** Two methods for you to select: **Reference SOC** and **Immediately**. **Reference SOC:** Turn on/off the generator according to the set battery SOC. **Immediately:** Turn on /off the generator immediately when the inverter disconnects from the grid.

```
====ExternalGen====
>Start Gen Method
Reference soc
```

```
====ExternalGen====
>Start Gen Method
Immediately
```

- » **Switch on/off SOC:** the option is activated when you select **Reference SOC** for **Start Gen Method**. The inverter will turn on the generator when the battery reaches the set **Switch on SOC** and turn it off when the battery reaches the set **Switch off SOC**.

```
====ExternalGen====
>Switch on SoC
0%
```

```
====ExternalGen====
>Switch off SoC
0%
```

- » **MaxRunTime:** Maximum operating time of generator. (1000 mins by default)

```
====ExternalGen====
>MaxRunTime
1000 Min
```

- » **MinRestTime:** Minimum time interval for two consecutive starts to avoid switching on and off frequently. (60 mins by default)

```
====ExternalGen====
>MaxRestTime
60Min
```

- » **Char&Disc Period:** Including **Forced Charge Period** and **Allowed Disc Period**. Two periods can be set at most.

```
====ExternalGen====
>Forced Chrg Period
Start Time
00:00
```

```
====ExternalGen====
>Allowed Disc Period
Start Time
00:00
```

```
====ExternalGen====
>Forced Chrg Period
End Time
00:00
```

```
====ExternalGen====
>Allowed Disc Period
End Time
23:59
```

- » **Allow Work:** Allowed time period for generator operating. You can set the start time and end time.

```
====ExternalGen====
>Allow Work
Start Time
00:00
```

```
====ExternalGen====
>Allow Work
End Time
23:59
```

- » **Charge from Gen and Charge battery to:** It allows the battery to take power from the generator. You can set the battery target SOC (10-100%, 10% by

default).

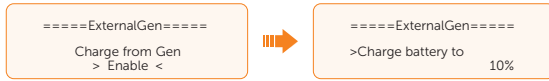

15.2 Application of Adapter Box G2

15.2.1 Introduction of Adapter Box G2 Application

With the SolaX Adapter Box G2, users can effectively utilize solar energy by commanding it to power their heat pump using settings available on the SolaX inverter and SolaXCloud. This intelligent integration allows for optimized solar self-consumption and ultimately helps in reducing electricity bills.

15.2.2 Wiring Connection Diagram

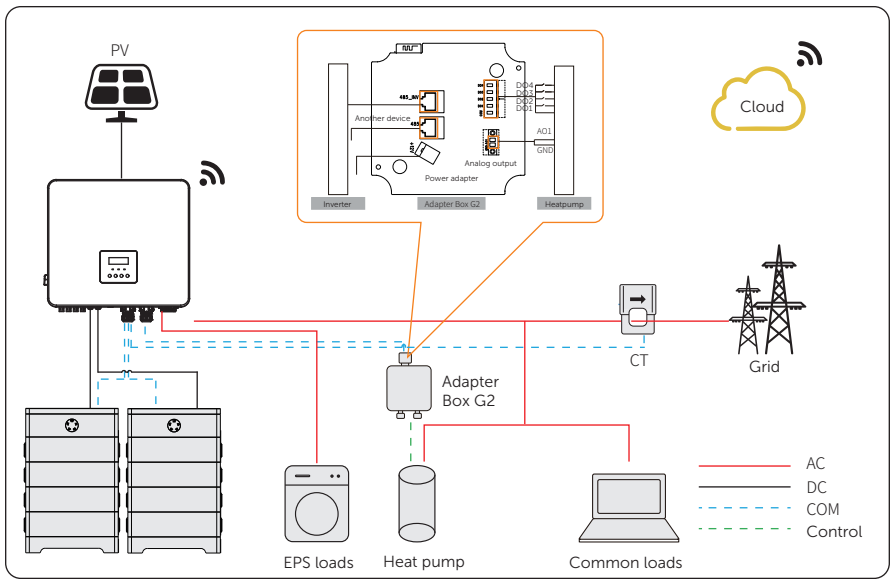

Figure 15-4 Adapter Box G2 wiring diagram

The inverter communicates with Adapter Box G2 via RS485. In case of excess power, the Adapter Box G2 can utilize it to heat the pump through the connection of dry contacts, SG Ready, or Analog output between the Adapter Box G2 and the heat pump. To power the Adapter Box G2, an external power adapter is required as the inverter itself cannot supply power to the Adapter Box G2.

15.2.3 Communication Connection with Inverter

- Connection port-Subport HEATPUMP in Port COM 2

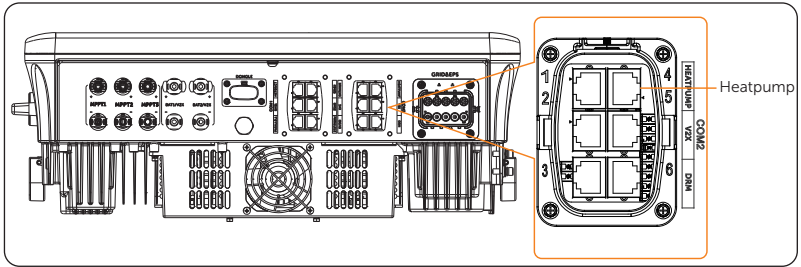

Figure 15-5 Connection port for Adapter Box G2

- Connection pins

Table 15-2 Pin-to-pin connection for inverter and Adapter Box G2

Subport HEATPUMP of inverter		Port RS485 of Adapter Box G2	
Pin	Definition	Pin	Definitions
4	HEATPUMP_485A_ CON	4	RS485-A
5	HEATPUMP_485B_ CON	5	RS485-B

- Connection steps: Please refer to “8.7.2 Datahub, heatpump, and EVC communication connection” for specific wire making and connection.

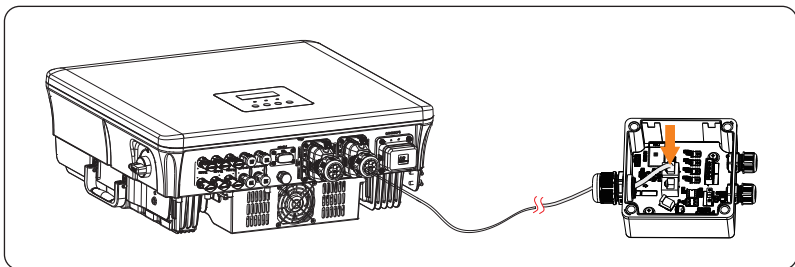

Figure 15-6 Connecting to Adapter Box G2

NOTICE!

- The communication cable between Adapter Box G2 and inverter cannot exceed 100 m.

15.2.4 Settings for Adapter Box G2

- a. Select **Menu>Settings>Advanced Settings>Peripheral Settings>Solax485**.
- b. Select **AdapBox G2** and set the **Baud Rate** and corresponding address. The default **Baud Rate** is 9600.

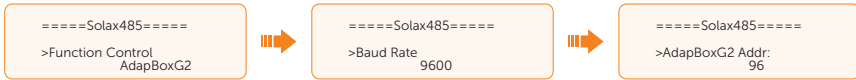

NOTICE!

- When two devices need to be connected at the same time, the baud rate and address of the two devices shall be set to the same.

- c. Check the connection status.

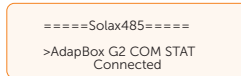

NOTICE!

- For specific wiring and setting procedures of Adapter Box G2, refer to *Adapter Box G2 User Manual*.

15.3 Application of EV-Charger

15.3.1 Introduction of EV-Charger Application

The EV-Charger is intended for charging electric vehicles. It should be installed in a fixed location and connected to the AC supply. The EV-Charger can communicate with other devices or systems (inverter, meter, CT, third-party charger management platform, etc.) to realize intelligent control of charging process.

15.3.2 Wiring Connection Diagram

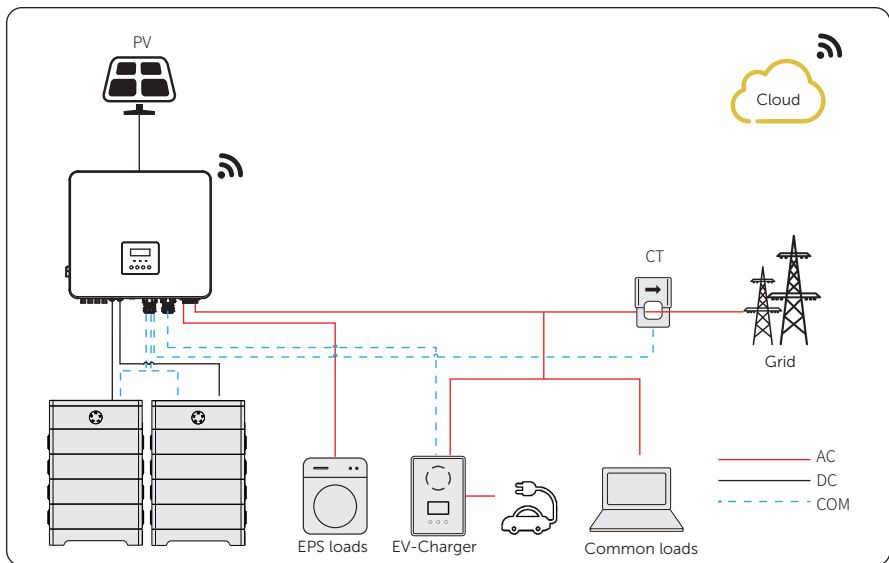

Figure 15-7 EV-Charger wiring diagram

15.3.3 Charging Modes

- Green mode: In Green mode, the EV-Charger will maximize the use of surplus power generated from the inverter. According to the minimum start-up charging power, the charging current can be divided into two levels: 3 A and 6 A. The default level is 3 A. If at any time, the available surplus power falls below the minimum start-up charging power, the EV-Charger will stop charging.
- Eco mode: In Eco mode, the charging power is continuously adjusted according to changes in generation or power consumption elsewhere in the house, thereby minimizing the use of the grid power. In this mode, users can set charging current at five different levels, i.e. 6 A, 10 A, 16 A, 20 A and 25 A (Only 6 A & 10 A for 11 kW models). If at any time, the available surplus power falls below the minimum start-

up charging power, such as 4.2 kW for three-phase, the shortfall will be drawn from the grid.

- Fast mode (Default mode): In Fast mode, the EV-Charger will charge the EV at the fastest rate regardless of whether the power generated by PV is sufficient and import grid electricity if the power generated by PV is insufficient.

15.3.4 Communication Connection with Inverter

- Connection port-Support EVC in Port COM 2

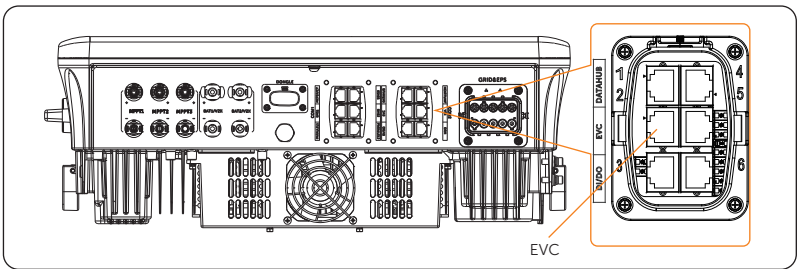

Figure 15-8 Connection port for EV-Charger

- Connection pins

Table 15-3 Pin-to-pin connection for inverter and EV-Charger

Support EVC of inverter		Port COM of EV-Charger	
Pin	Definition	Pin	Definition
4	EVC_485A_CON	5	B1
5	EVC_485B_CON	4	A1

- Connection steps: Please refer to [“8.7.2 Datahub, heatpump, and EVC communication connection”](#) for specific wire making and connection.

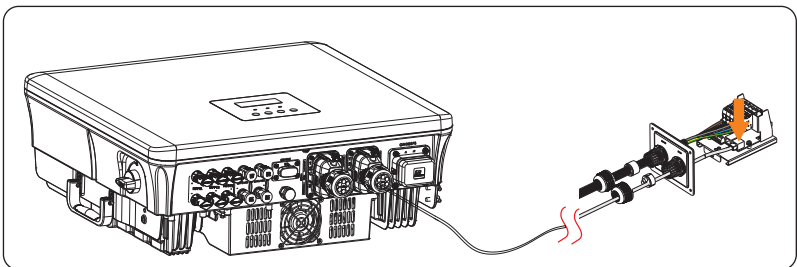

Figure 15-9 Connecting to EV-Charger

NOTICE!

- The communication cable between EV-Charger and inverter cannot exceed 100 m.

15.3.5 Settings for EV-Charger

- Select **Menu>Settings>Advanced Settings>Peripheral Settings>Solax485**.
- Select **EVCharger** and set the **Baud Rate** and corresponding address. The default **Baud Rate** is 9600.

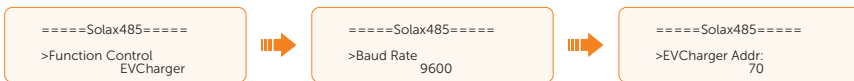

NOTICE!

- When two devices need to be connected at the same time, the baud rate and address of the two devices shall be set to the same.

- Check the connection status.

```

====Solax485====
>EV Charger COM STAT
Connected
  
```

- (optional) You can enable **Battery Charge EVC** to allow the battery to discharge energy to the EV-Charger through setting path: **Menu>Settings>Advanced Settings>Battery Settings>Battery Charge EVC**.

```

===Battery Charge EVC===
>Function Control
Enable
  
```

NOTICE!

- For specific wiring and setting procedures of EV-Charger, refer to *X1/X3-EVC Series User Manual*.

15.4 Application of DataHub

15.4.1 Introduction of DataHub Application

SolaX DataHub can be connected to inverters through Port COM2 DATAHUB to control the output power of the entire power station according to on-site requirements. Besides, it can work with SolaXCloud to monitor all inverters, allowing for real-time data display and device management. In the entire system, a maximum of 60 X3-HYB-G4 PRO series inverters can be connected to the DataHub.

15.4.2 Wiring Connection Diagram

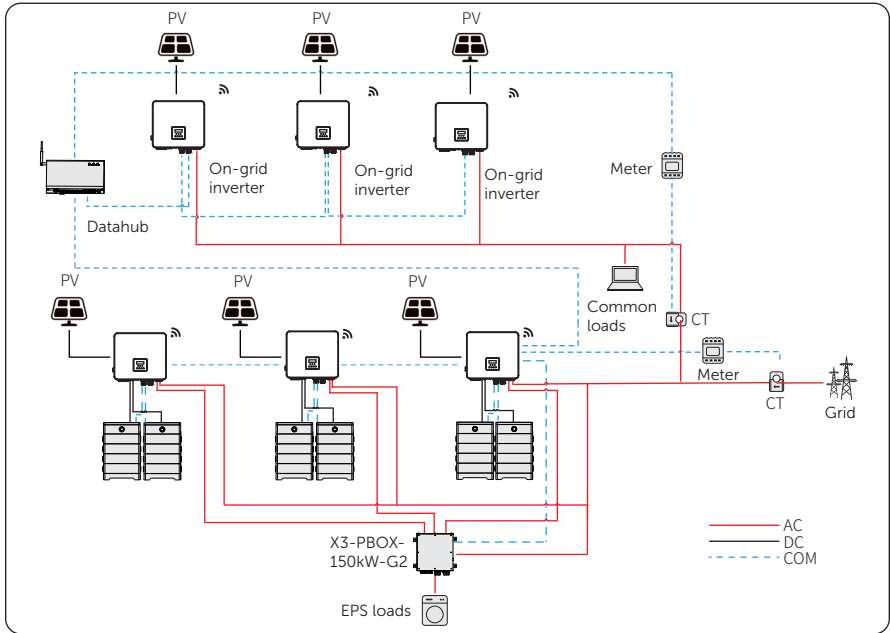

Figure 15-10 DataHub wiring diagram

15.4.3 Communication Connection with Inverter

- Connection port-Support Datahub in Port COM 2

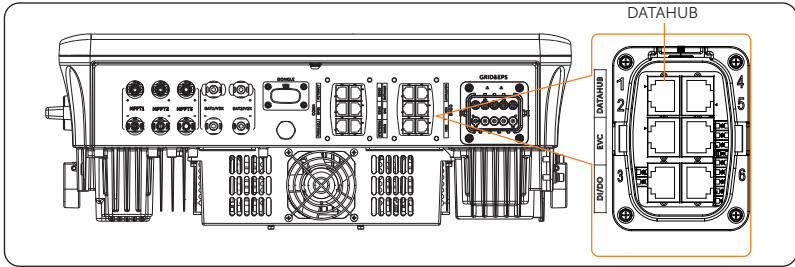

Figure 15-11 Connecting port for DataHub

- Connection pins

Table 15-4 Pin-to-pin connection for inverter and DataHub

Support DATAHUB of inverter		Port RS485-1 of DataHub	
Pin	Definition	Pin	Definition
4	DATAHUB_485A_ CON	/	A+
5	DATAHUB_485B_ CON	/	B-

- Connection steps: Please refer to [“8.7.2 Datahub, heatpump, and EVC communication connection”](#) for wire making and connecting.

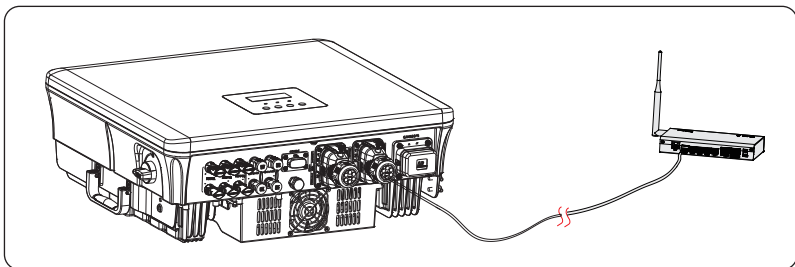

Figure 15-12 Connecting to DataHub

NOTICE!

- The communication cable between DataHub and inverter cannot exceed 100 m.

15.4.4 Settings for DataHub

- a. Select **Menu>Settings>Advanced Settings>Peripheral Setstings>Solax485**.
- b. Select **Datahub** and set the **Baud Rate** and corresponding address. The default **Baud Rate** is 9600.

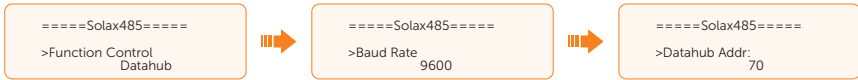

NOTICE!

- The baud rate, communication protocol and verification method of the inverters connected to the same RS485 port of DataHub must be consistent, and the communication addresses of the inverters must be consecutive and not repeated.

NOTICE!

- For specific wiring and setting procedures of DataHub, refer to *DataHub 1000 User Manual*.

15.5 Application of Micro-grid

15.5.1 Introduction of Micro-grid Application

Due to the islanding effect, an on-grid inverter cannot work during off-grid. This characteristic makes user losing the on-grid inverter PV energy when off-grid. Micro-grid is the function that making hybrid inverter simulate the grid to active on-grid inverter during off-grid by connecting the on-grid inverter to hybrid inverter's EPS port.

15.5.2 Wiring Conenction Diagram

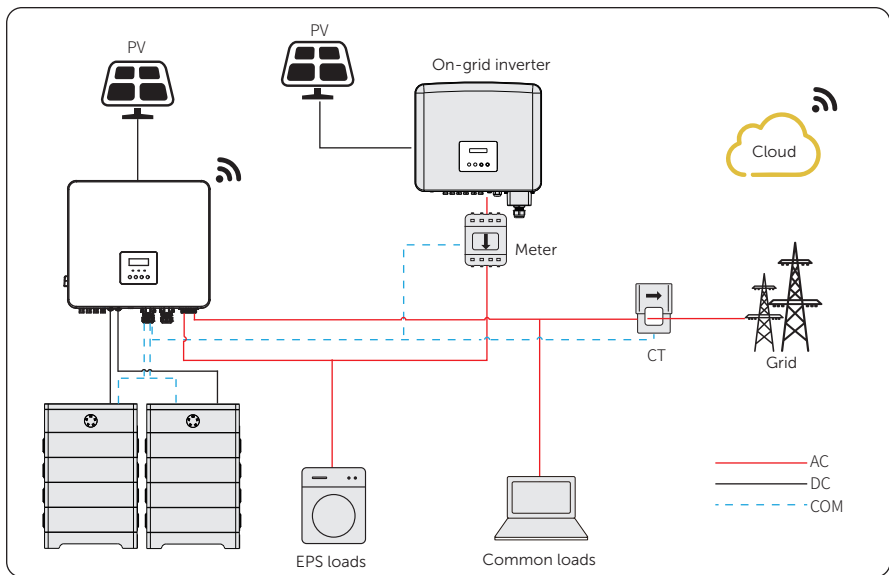

Figure 15-13 Micro-grid wiring connection

15.5.3 Working Modes

Grid on

- When PV is sufficient, the hybrid and on-grid inverters power the common and EPS loads together. When there is surplus energy on the on-grid inverter, it will also charge the battery.
- When PV is insufficient, the hybrid inverter, on-grid inverter and grid power the loads together.

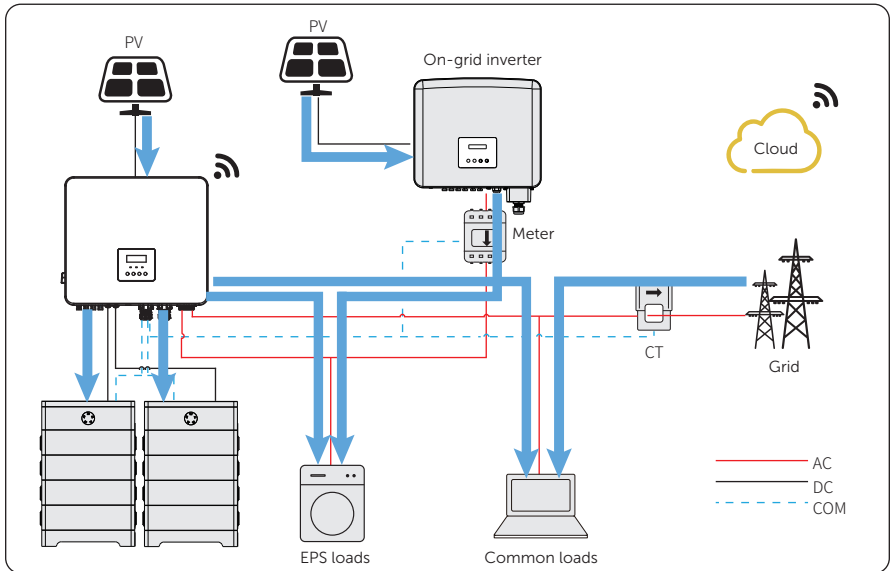

Figure 15-14 Power flowing when grid on and PV sufficient

Grid off

In this case, the hybrid inverter will simulate the grid so as to make the on-grid inverter work. Hybrid and on-grid inverter will power the EPS loads together. If there is surplus energy, it will charge the battery.

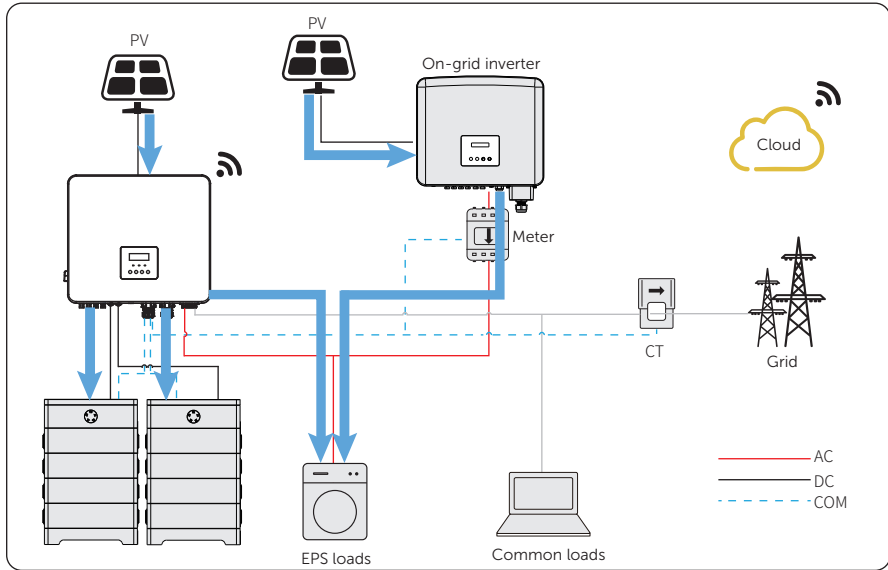

Figure 15-15 Power flowing when grid off

NOTICE!

- In EPS mode, due to limited battery charging power, the hybrid inverter will increase the EPS output frequency to restrict and shut down the on-grid inverter, ensuring the stable operation of the entire system. In this period, the on-grid inverter may report a **Grid frequency Fault**, which is a normal phenomenon.

Notice for micro-grid application

- Any brand of on-grid inverter that supports "frequency adaptation"
- On-grid inverter output power \leq Max hybrid inverter EPS output power
- On-grid inverter output power \leq Max battery charging power

NOTICE!

- Since X3-HYB-G4 PRO series inverter is unable to control the output power of on-grid inverter in grid connection mode, the series inverter cannot achieve zero export when "loads power + battery charging power < on-grid inverter output power".

15.5.4 Cable Connection (Hybrid inverter)

Please refer to "8.3 AC Connection" for Grid and EPS connection on X3-HYB-G4 PRO series inverter.

15.5.5 Cable Connection (On-grid inverter)

Please connect the AC cable of an on-grid inverter to the EPS port of X3-HYB-G4 PRO series inverter. Please refer to the user manual of specific on-grid inverter.

15.5.6 Cable Connection (Meter)

To detect and monitor the power data generated from the on-grid inverter, install a meter on the on-grid inverter side. Otherwise, the relevant power data of on-grid inverter cannot be monitored.

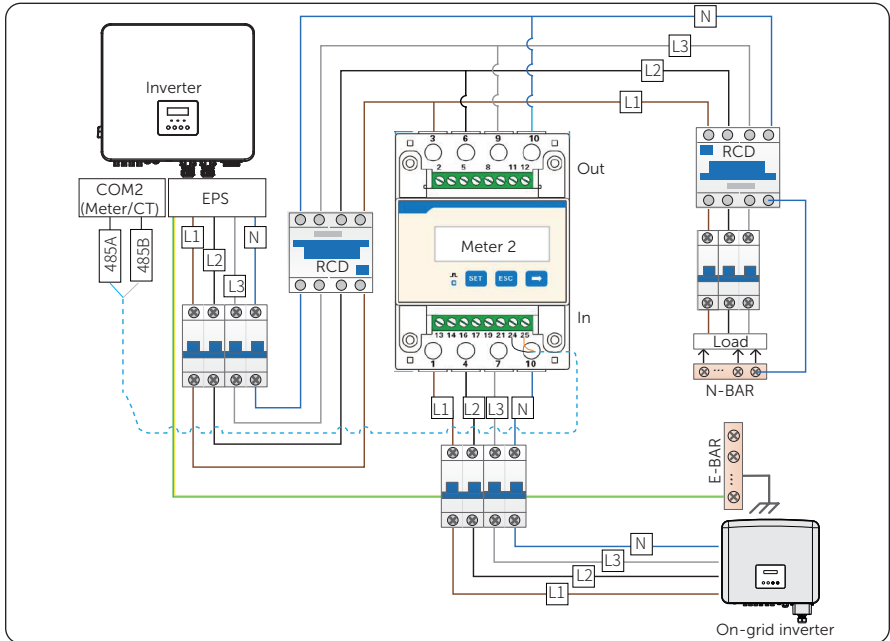

Figure 15-16 Connection diagram of Meter on EPS port

- Pin assignment

Table 15-5 Pin assignment for meter and CT

Pin	Definition	Description
1	CT_R1_CON	
2	CT_S1_CON	For CT connection
3	CT_T1_CON	
4	METER _485A	For meter connection
5	METER _485B	
6	CT_T2_CON	
7	CT_S2_CON	For CT connection
8	CT_R2_CON	

- For meter/CT connection steps, refer to ["8.6.2 Meter/CT Connection"](#) and meter/CT user manual.
- Settings on the LCD:
 - Select **Menu>Settings>Advanced Settings>Meter/CT Settings**.
 - Set parameters for meter or CT:
 - Situation 1: CT is used for monitor the hybrid inverter, and Meter 2 is used to monitor the EPS port. Select **CT** and set the type of CT according to the actual situations. Set the address and direction of Meter 2. After all done, you can check the connection status of meter and CT at Meter/CT Check.



- Situation 2: Meter 1 is used for monitor the hybrid inverter, and Meter 2 is used to monitor the EPS port. Select **Meter** and set the address and direction of Meter 1. For settings about Meter 2, refer to Situation 1. After all are done, you can check the connection status of meters through **Meter/CT Check**.



- c. If meter/CT connection succeeds, check the feed-in power of Meter 1 in the path of **Menu>System Status>Meter/CT** and check the output power (**Output Today** and **Output Total**) of Meter 2 in the path of **Menu>History Data>E_USERDEF**.

NOTICE!

- CT and Meter 1 cannot be used at the same time.

15.6 Application of Parallel Function

15.6.1 Introduction of Parallel Application

The series inverters supports parallel operation in both Grid and EPS modes. It can be configured with SolaX X3-PBOX-150kW-G2 or without one. Without X3-PBOX-150kW-G2, it supports up to 5 units in the parallel system, while with X3-PBOX-150kW-G2, it supports up to 10 units. Details as follows:

Table 15-6 Maximum inverter number in parallel system

	X3-HYB-4.0-P	X3-HYB-5.0-P	X3-HYB-6.0-P	X3-HYB-8.0-P	X3-HYB-10.0-P	X3-HYB-12.0-P	X3-HYB-15.0-P
With X3-PBOX-150kW-G2	10	10	10	10	10	10	10
Without X3-PBOX-150kW-G2				5			

* Up to 10 inverters can be connected in parallel when there is no EPS connection.

15.6.2 Notice for Parallel Application

- All inverters should be of the same software version.
- For optimal efficiency, it is recommended that all inverters have the same model, and are connected to batteries of the same model and quantity.
- In parallel system, there are three status for devices: **Free**, **Slave** and **Master**.

Table 15-7 Status of devices in parallel system

Free	No one inverter is set to be the master inverter and all inverters are free.
Slave	Once one inverter is set as Master , all other inverters automatically become slave inverters. Its subordinate identity cannot be changed through the LCD.
Master	You can select one inverter and set it as Master , and then the master inverter dominates the parallel system. You can also change its identity into Free .

- Master inverter has an absolute lead in the parallel system to control all slave inverter's energy management and dispatch control. Once master inverter has some error and stop working, all slave inverters will be stop simultaneously. But master inverter is independent of all slave inverters to work and will not be affected by slave inverter's fault.

- Overall system will be running according to master inverter's setting parameters, and most setting parameters of slave inverter will be kept but not be cancelled.
- Once slave inverter exits from the system and be running as an independent unit (the network cable is disconnected simultaneously), its all setting will be re-activated.
- The parallel system is extremely complex and requires a large number of cables to be connected. Therefore, the cables must be connected in the correct wire sequence. Otherwise, any small mistake can lead to system failure.
- The communciation cable length should not exceed 30 m.

15.6.3 System Wiring Diagram

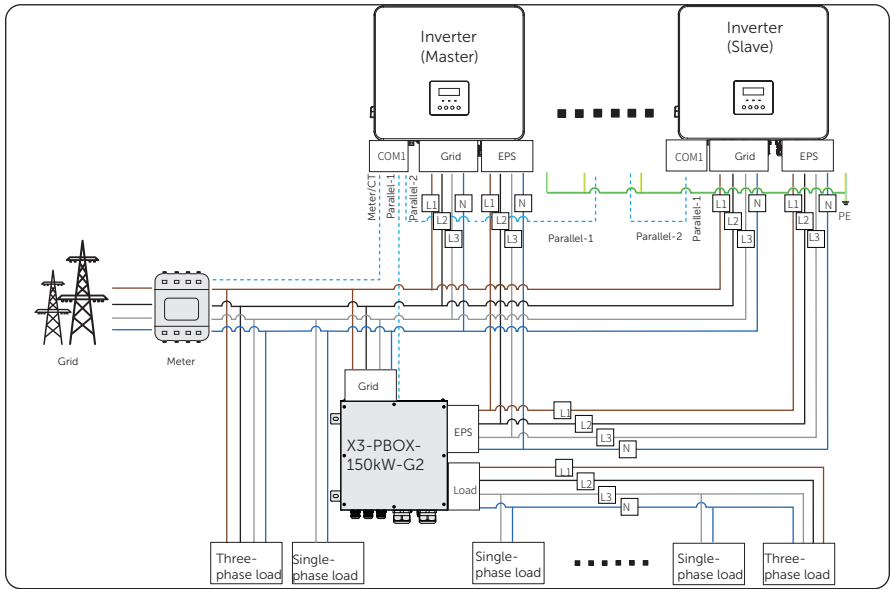

Figure 15-17 With X3-PBOX-150kW-G2 system wiring diagram

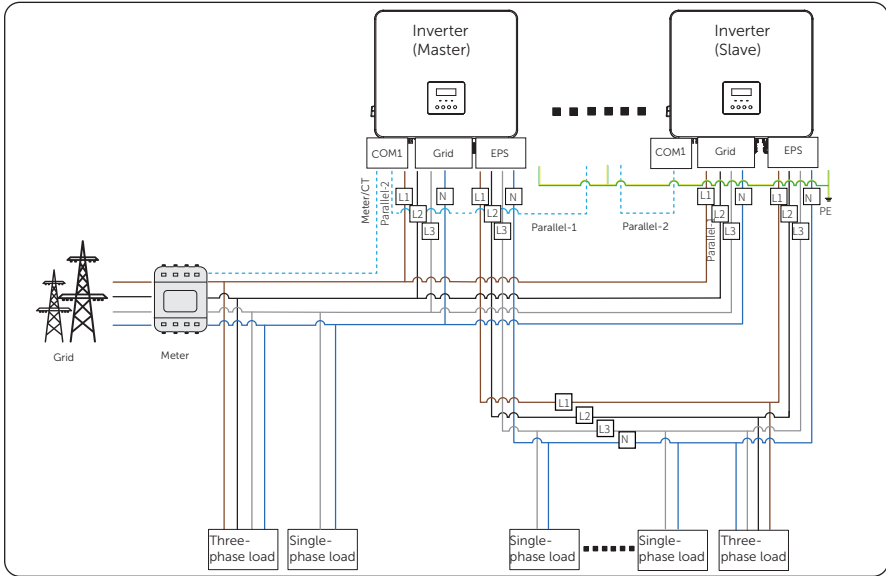

Figure 15-18 Without X3-PBOX-150kW-G2 system wiring diagram

15.6.4 System Wiring Procedure

Power cable wiring-Grid and EPS port

- With X3-PBOX-150kW-G2:
 - a. Connect the master inverter, slave inverters and Master-X3-PBOX-150kW-G2 with the five-core copper cable.
 - b. Grid port of the master, slave inverters and X3-PBOX-150kW-G2: L1 connects to L1, L2 connects to L2, L3 connects to L3 and N connects to N.
 - c. EPS port of the master, slave inverters and X3-PBOX-150kW-G2: L1 connects to L1, L2 connects to L2, L3 connects to L3 and N connects to N.
 - d. All PE cable connects to the same E-BAR nearby.

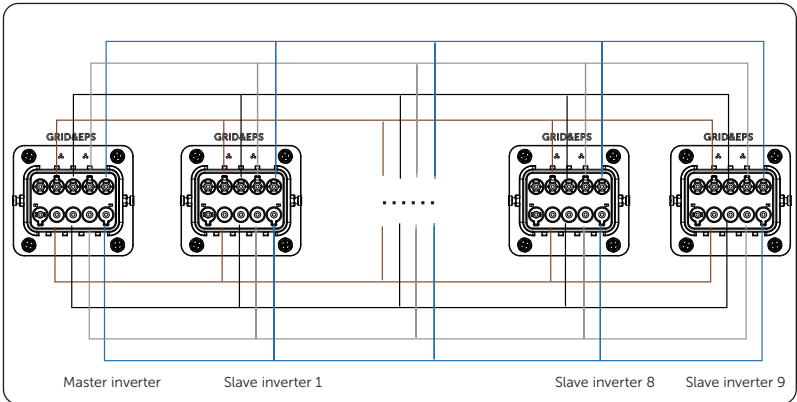

Figure 15-19 Power cable wiring with X3-PBOX-150kW-G2

- Without X3-PBOX-150kW-G2
 - a. Connect the master inverter and slave inverters with the five-core copper cable.
 - b. Grid port of the master inverter and slave inverters: L1 connects to L1, L2 connects to L2, L3 connects to L3 and N connects to N,
 - c. EPS port of the master inverter and slave inverters: L1 connects to L1, L2 connects to L2, L3 connects to L3 and N connects to N,
 - d. All PE cable connects to the same E-BAR nearby.

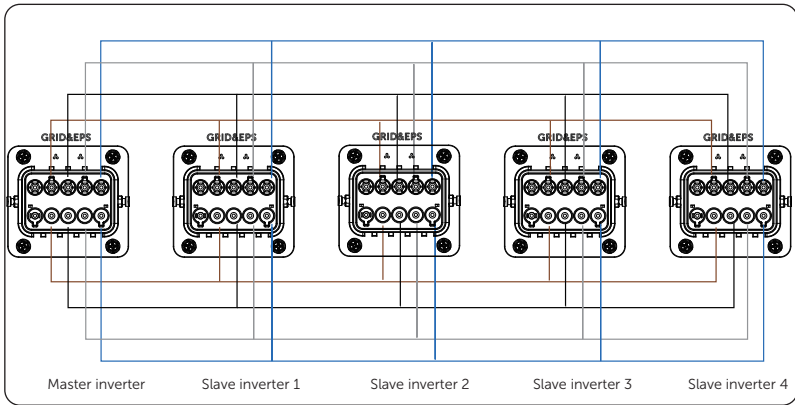

Figure 15-20 Power cable wiring without X3-PBOX-150kW-G2

Communication cable wiring-COM1 port

- With X3-PBOX-150kW-G2.
 - a. Connect the master inverter, slave inverters and X3-PBOX-150kW-G2 with a standard network cable.
 - b. Master inverter Parallel-1 connects to the COM port of X3-PBOX-150kW-G2.
 - c. Master inverter Parallel-2 connects to Slave 1 inverter Parallel-1;
 - d. Slave 1 Parallel-2 connects to Slave 2 Parallel-1; other inverters are connected in such way.
 - e. Meter connects to Meter/CT support of the Master inverter. Please refer to "8.6.2 Meter/CT Connection".

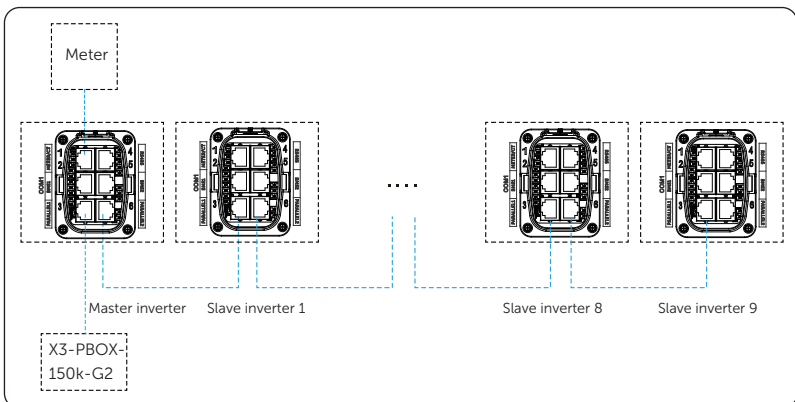

Figure 15-21 Communication wiring with X3-PBOX-150kW-G2

- Parallel connection without X3-PBOX-150kW-G2.
 - a. Connect the master inverter and slave inverters with a standard network cable.
 - b. Master inverter Parallel-2 connects to Slave 1 inverter Parallel-1.
 - c. Slave 1 inverter Parallel-2 connects to Slave 2 inverter Parallel-1.
 - d. Meter connects to Meter/CT support of the Master inverter. Please refer to ["8.6.2 Meter/CT Connection"](#).

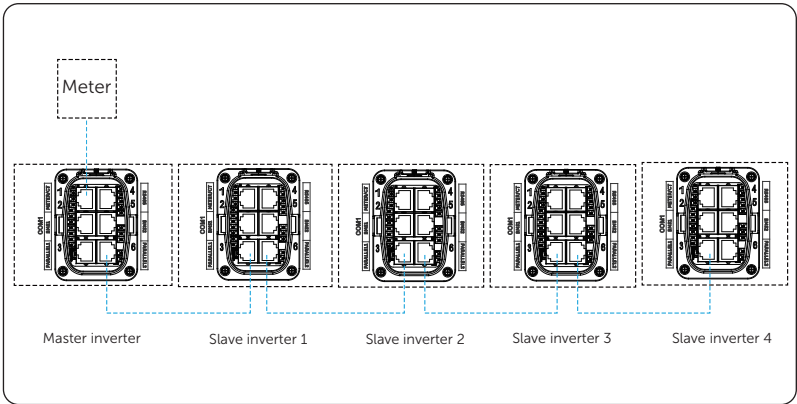

Figure 15-22 Communication wiring without X3-PBOX-150kW-G2

NOTICE!

- For details about the parallel connection of X3-PBOX-150kW-G2, refer to *X3-PBOX-150kW-G2 Installation Guide*.
- For details on the specific wiring of the inverter, refer to ["8.3 AC Connection"](#) and ["8.6.5 Parallel Connection"](#).

15.6.5 Settings for Parallel Connection

Meter/CT setting

Setting path: **Menu>Settings>Advanced Settings>Meter/CT Settings**. For details, refer to "Meter/CT Settings".

Parallel setting

Setting path: **Menu>Settings>Advanced Settings>Parallel Settings**.

How to build the parallel connection

- Open the power supply for all inverters. Select an inverter and connect a meter to the inverter. Enter the LCD of the inverter and select **Menu>Settings>Advanced Settings>Parallel Settings**. Set the inverter as **Master** and set **Resistance Switch** to **ON**. If settings succeed, the other inverters automatically become slave inverters.



- Find the last slave inverter in the parallel system and set **Resistance Switch** to **ON**.

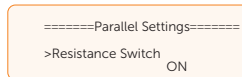

How to remove the parallel connection

- Find the inverter which needs to be set as Free. Select the **Parallel Settings** and select **Free** for the inverter.

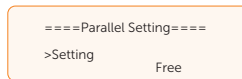

- Disconnect all the network cables on the Parallel-1 and Parallel-2 supports.

NOTICE!

- If a slave inverter is set to **Free** but not disconnect the network cable, this inverter will return to **Slave** automatically.
- If a slave inverter is disconnected with master inverter but not be set to **Free**, this slave inverter will stop working and prompt **ParallelFault**.

External ATS setting

Setting path: **Menu>Settings>Advanced Settings>Parallel Settings>External ATS**.

When a X3-PBOX-150K G2 is connected in the parallel system, you need to enable the function.

```
====External ATS====  
Function Control  
> Disable <
```

Parallel display

Displaying path: **Menu>Parallel Status**

NOTICE!

- Once an inverter enters the parallel system, the **Today** yield will be replaced by **Parallel**.

In **Parallel Status** interface, the whole system power and individual slave inverter power can be obtained in **Parallel Status** interface of master inverter. The number displayed in the **Parallel Status** interface refers to the total number of online inverters, for example two inverters in parallel in the below figure.

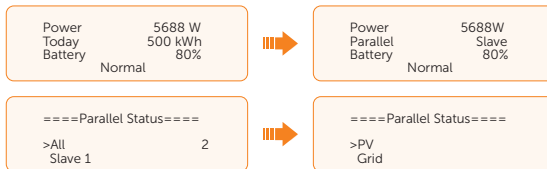

15.7 CT/Meter Connection Scenarios

X3-HYB-G4 PRO inverter series can be connected to a single batch of CTs, a direct-connected meter, or a CT-connected meter, and also support a Meter 2 function for you to monitor another power generation device at home.

The following are the detailed wiring and setting procedures of these scenarios. For wiring procedure of the inverter CT/Meter port, see "8.6.2 Meter/CT Connection".

15.7.1 Connection of CT

NOTICE!

- Do not place the CT on the N wire or ground wire.
- Do not place CT on the N line and L line at the same time.
- Do not place the CT on non-insulated wires.
- The cable length between CT and inverter should not exceed 100 meters.
- After CT is connected, prevent the CT clip from falling off. It is recommended to wrap the CT clip around in circles with insulating tape.

NOTICE!

- The CTs referred to in this section are the CT batch delivered with the inverter.

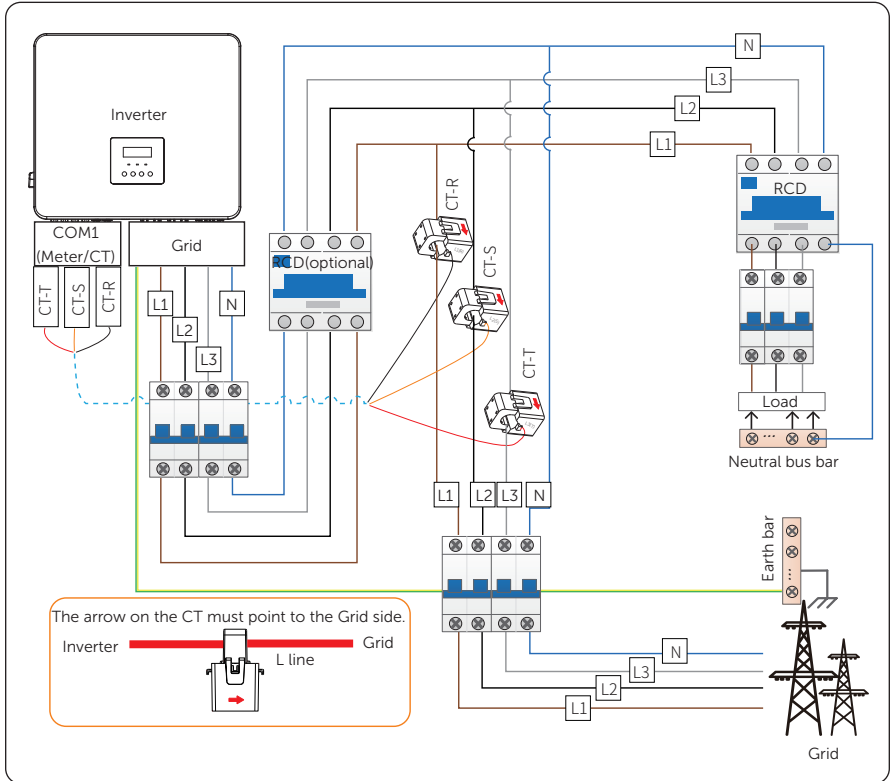

Figure 15-1 System wiring with CT

* The arrow on the CTs must point at the public grid.

*Markings on the CTs might be R, S and T or L1, L2 and L3. Make sure to clip CT-R/CT-L1 to the L1 wire, CT-S/CT-L2 to the L2 wire, and CT-T/CT-L3 to the L3 wire.

*The emergency load is connected to the EPS port of the inverter, which is not shown in the diagram.

Wiring Procedure

- Step 1:** Clip CT_R, CT_S and CT_T respectively onto the L1, L2 and L3 cables of the grid. Make sure the arrow on the CTs is pointing to the grid side from the inverter.

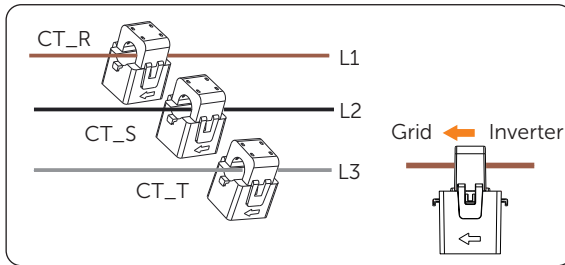

Figure 15-2 Clipping CTs to grid cables

- Step 2:** Use the RJ45 connector (part R) to connect the extension communication cable and the batch of CTs.

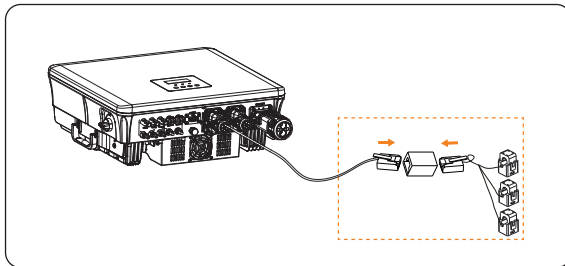

Figure 15-3 Connecting the inverter to the CT

Setting Procedure

After connecting CTs to the inverter, set parameters for them on the inverter.

- Step 1:** Select **Advanced Settings > Meter/CT Settings > CT**.

- Step 2:** Select the supported CT type.

You can check the connection status in **Meter/CT Check**. For details, see [“Meter/CT Settings”](#)



15.7.2 Connection of Direct-connected Meter

NOTICE!

- SolaX DTSU666 is used as an example.

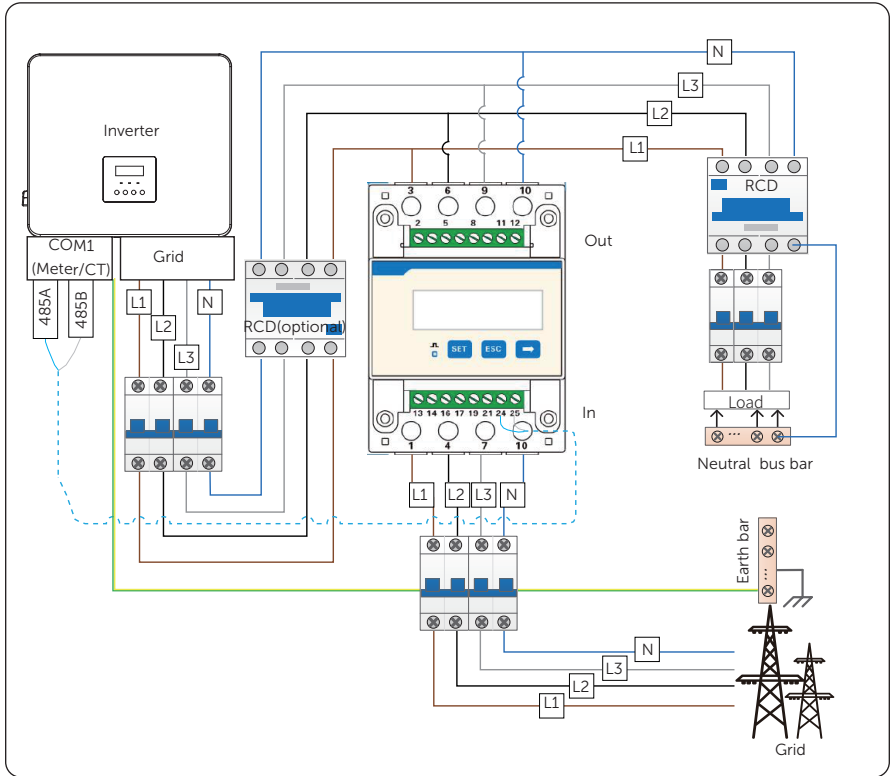

Figure 15-4 System wiring with direct-connected meter

*For direct-connected meter, the current flow direction should be from grid to the inverter.

*Terminals 1, 4 and 7 of the meter must be connected to the grid side, and terminals 3, 6 and 9 be connected to the inverter side of the system. Otherwise, the system power data might be misread.

Meter Terminal Definition

Table 15-1 Terminal definition of SolaX direct-connected meter

Terminal No.	Definition	Description
1, 4, 7	UL*	Voltage input terminal of the three phases (the grid side), respectively connected to L1, L2 and L3
3, 6, 9	UL	Voltage output terminal of the three phases (the inverter side), respectively connected to L1, L2 and L3
10	UN	Phase N voltage input and output terminal, connected to the N wire
24	RS485A	RS485 terminal A
25	RS485B	RS485 terminal B

Wiring Procedure

Step 1: Strip around 10 mm wire insulation off the grid voltage cables, and then connect L1, L2 and L3 wires respectively to terminal 1 and 3, 4 and 6, 7 and 9, and N wire to terminal 10 of the meter.

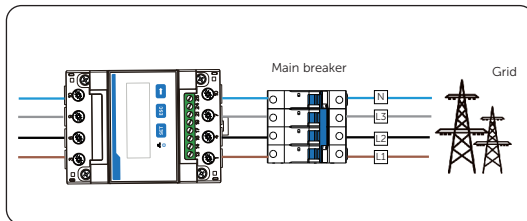

Figure 15-5 Connecting direct-connected meter to the grid

Step 2: Strip 15 mm wire insulation off the other end of the communication cable.

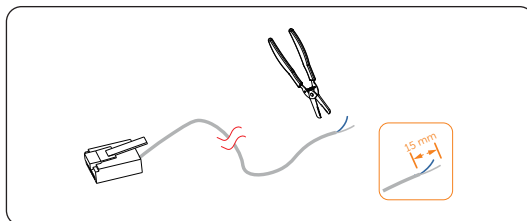

Figure 15-6 Stripping communication cable for meter

Step 3: Connect the conductors to terminal 24 and 25 of the meter.

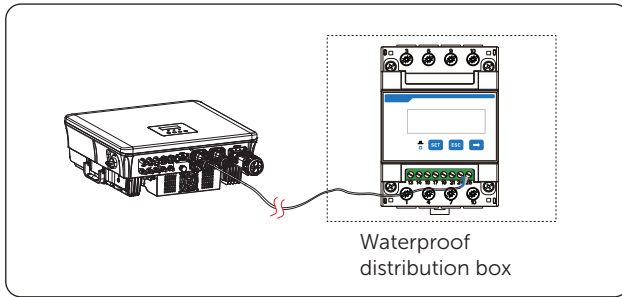

Figure 15-7 Connecting inverter to meter

Setting Procedure

After connecting the meter to the inverter, set parameters for it on the inverter.

Step 1: Select **Advanced Settings > Meter/CT Settings > Meter**.

Step 2: Set **Meter1Addr** to **1** and **Meter1 Direction** to **Positive**.

You can check the connection status in **Meter/CT Check**. For details, see "[Meter/CT Settings](#)".

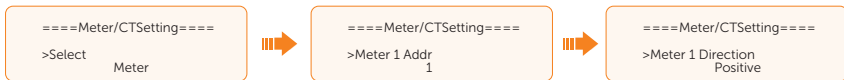

15.7.3 Connection of CT-connected Meter

NOTICE!

- SolaX DTSU666-CT is used as an example.
- The CTs referred to in this section are only CTs that are delivered with the CT-connected meter.

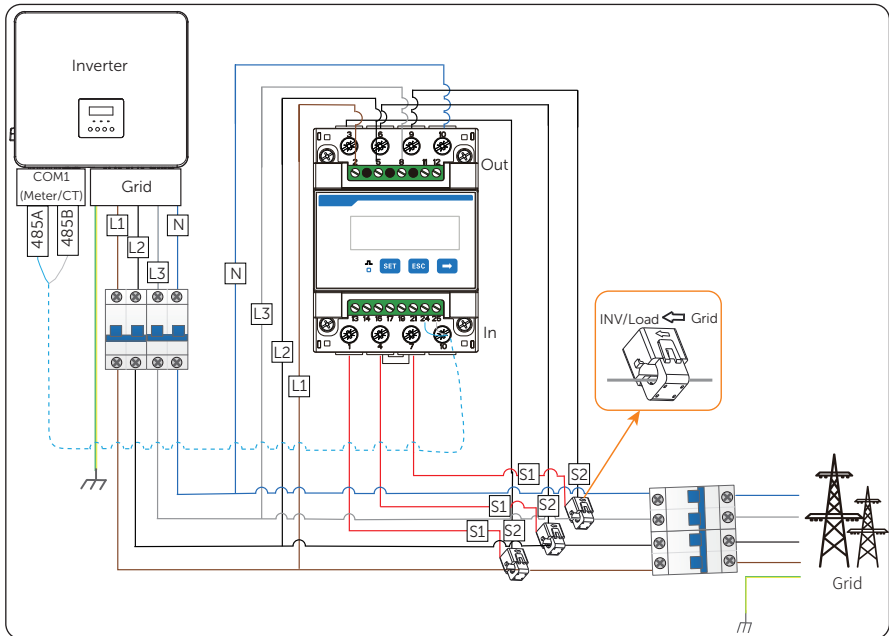

Figure 15-8 System wiring with CT-connected meter

*Terminal 2, 5 and 8 of the meter must be connected to the grid side. Terminal 1, 4 and 7 must be connected to the S1 wire of the CTs, and terminal 3, 6 and 9 be connected to the S2 wire of the CTs. Otherwise, the system power data might be misread.

*The arrow on the CTs must point at the inverter side.

Meter Terminal Definition

Table 15-2 Terminal definition of SolaX CT-connected meter

Terminal No.	Definition	Description
2, 5, 8	UL	Voltage input terminal of the three phases, respectively connected to L1, L2 and L3
10	UN	Phase N voltage input terminal, connected to the N wire
1, 4, 7	IA*, IB*, IC*	Current input terminal of the three phases, connected to the S1 wire of CTs
3, 6, 9	IA, IB, IC	Current output terminal of the three phases, connected to the S2 wire of CTs
24	RS485A	RS485 terminal A, connecting the communication wire from port METER_485 of the inverter
25	RS485B	RS485 terminal B, connecting the communication wire from port METER_485 of the inverter

Wiring Procedure

- Step 1:** Strip about 10 mm wire insulation off the voltage cables, and then connect L1, L2 and L3 wires respectively to terminal 2, 5 and 8, and the N wire to terminal 10 of the meter.
- Step 2:** Clip the CTs onto the L1, L2 and L3 wires in the direction from grid to inverter.
- Step 3:** Connect the S1 wire of the three included CTs respectively to terminal 1, terminal 4 and terminal 7, and S2 wire of the CTs respectively to terminal 3, 6 and 9 of the meter.

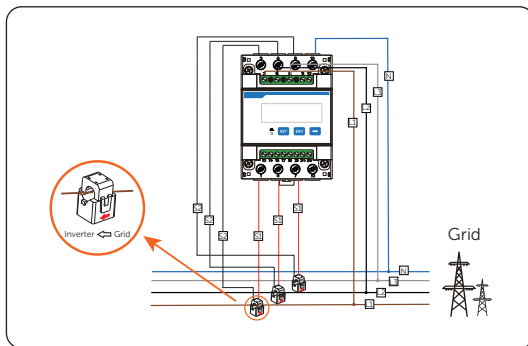

Figure 15-9 Connecting CT-connected meter to the grid

Step 4: Strip 15 mm wire insulation off the other end of the communication cable.

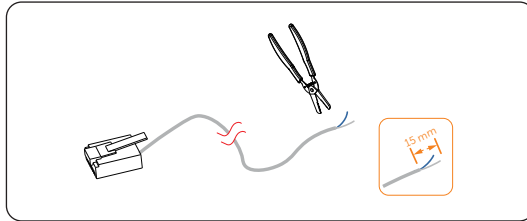

Figure 15-10 Stripping communication cable for meter

Step 5: Connect the conductors to terminal 24 and 25 of the meter.

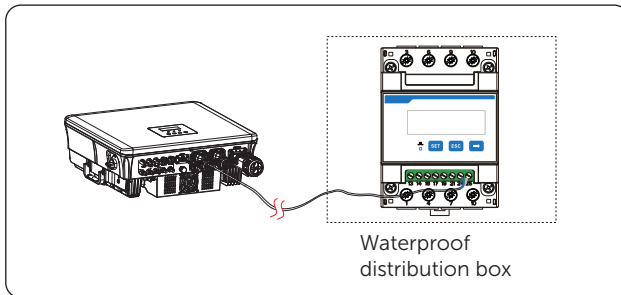

Figure 15-11 Connecting inverter to meter

Setting Procedure

After connecting the CT-connected meter to the inverter, set parameters for it on the inverter.

Step 1: Select **Advanced Settings > Meter/CT Settings > Meter**.

Step 2: Set **Meter1Addr** to **1** and **Meter1 Direction** to **Positive**.

You can check the connection status in **Meter/CT Check**. For details, see [“Meter/CT Settings”](#).

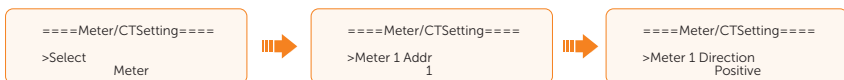

15.7.4 Connection of Two Meters

If you have two power generation devices (this inverter and the other one) and want to monitor both of them, this inverter provides Meter 2 communication function to help you achieve it.

NOTICE!

- For connecting CT and meter, or connecting two meters, prepare an RJ45 splitter adapter and a proper waterproof enclosure for it in advance.
- The device for monitoring the system (device at Meter 1 position) can be CT, direct-connected meter and CT-connected meter, but the device for monitoring another power generation device (device at Meter 2 position) can only be meters, either direct-connected meter or CT-connected meter. The following diagrams use the connection of CT and direct-connected meter for example.

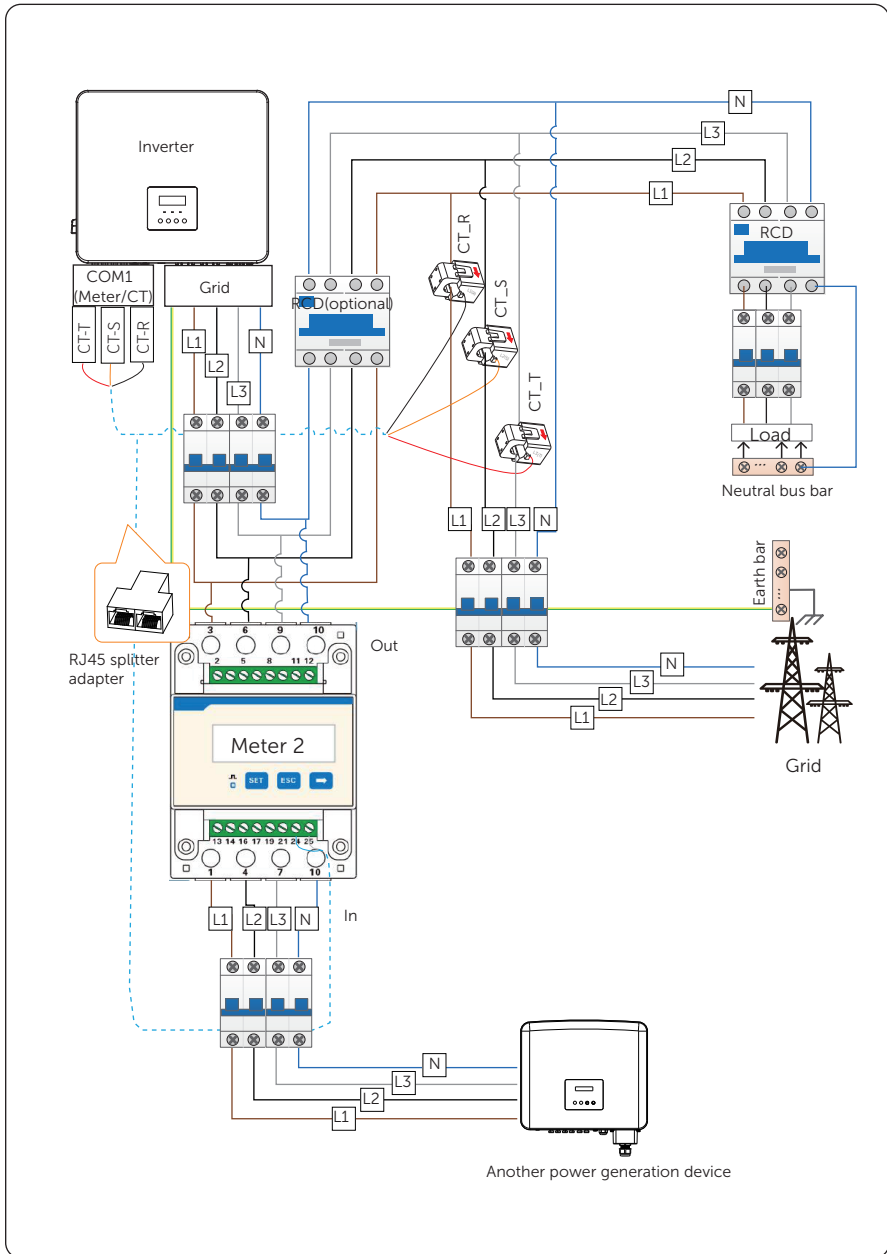

Figure 15-12 Connection diagram of CT and direct-connected meter

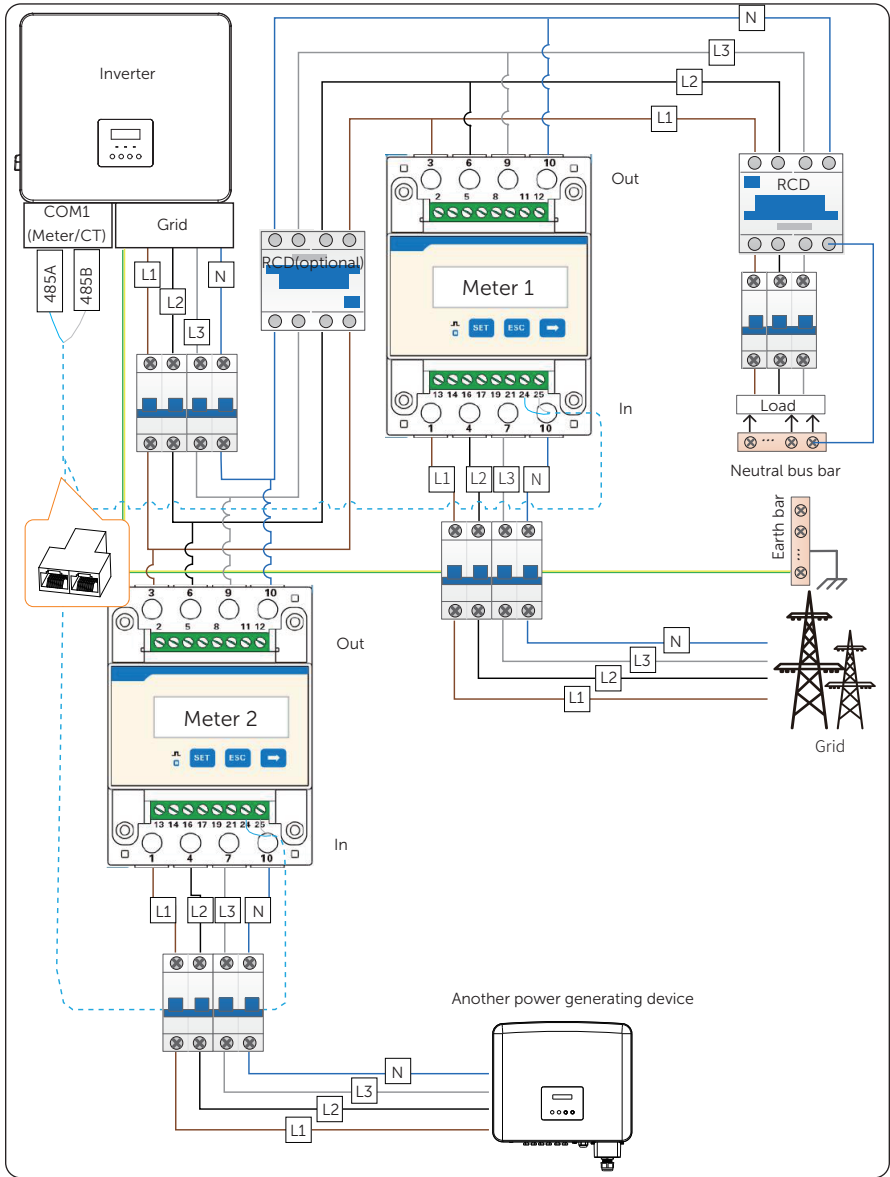

Figure 15-13 Connection diagram of two direct-connected meters

Wiring Procedure

Step 1: Follow the above steps to connect the meter, CT and inverter.

Step 2: Connect the RJ45 terminal to the RJ45 splitter adapter.

Setting Procedure

After connecting the CT and meter to the inverter, you need to set parameters on the inverter LCD before they can work normally for the system.

Step 1: Select **Advanced Settings > Meter/CT Settings**.

Step 2: Set the Meter/CT:

- » Case 1: CT and Meter 2 are connected (CT for SolaX inverter, Meter 2 for another power generation device). Select **CT** and set the CT type to 100 or 200 A according to the actual situations. Check whether the address and direction of Meter2 are set based on actual connection.

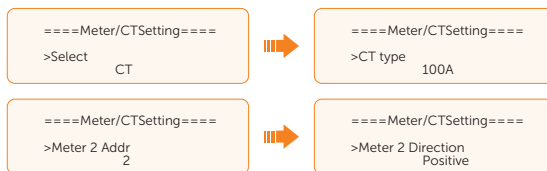

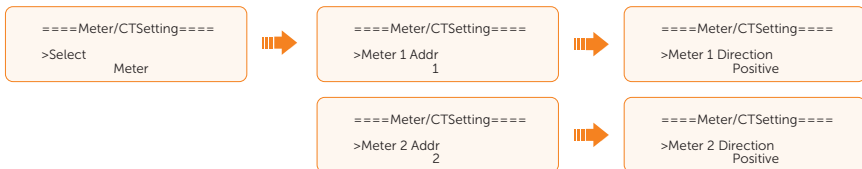

- » Case 2: Meter 1 and Meter 2 are connected (Meter 1 for SolaX inverter, Meter 2 for another power generation device). Select **Meter** and enable the Meter function. Check whether the address and direction of Meter 1 and Meter 2 are set based on actual connection.



Contact Information





UNITED KINGDOM

 Unit C-D Riversdale House, Riversdale Road, Atherstone, CV9 1FA
 +44 (0) 2476 586 998
 service.uk@solaxpower.com





TURKEY

 Fevzi Çakmak mah. asım cd. no 88 A Karatay / Konya / Türkiye
 service.tr@solaxpower.com



USA

 3780 Kilroy Airport Way, Suite 200, Long Beach, CA, US 90806
 +1 (408) 690 9464
 info@solaxpower.com





POLAND

 WARSAW AL. JANA P. II 27. POST
 +48 662 430 292
 service.pl@solaxpower.com



ITALY

 +39 011 19800998
 support@solaxpower.it





PAKISTAN

 service.pk@solaxpower.com



AUSTRALIA

 21 Nicholas Dr, Dandenong South VIC 3175
 +61 1300 476 529
 service@solaxpower.com.au







GERMANY

 Am Tullnaupark 8, 90402 Nürnberg, Germany
 +49 (0) 6142 4091 664
 service.eu@solaxpower.com
 service.dach@solaxpower.com





NETHERLANDS

 Twekkeler-Es 15 7547 ST Enschede
 +31 (0) 8527 37932
 service.eu@solaxpower.com
 service.bnl@solaxpower.com





SPAIN

 +34 9373 79607
 tecnico@solaxpower.com



BRAZIL

 +55 (34) 9667 0319
 info@solaxpower.com



SOUTH AFRICA

 service.za@solaxpower.com



SolaX Power Network Technology (Zhejiang) Co., Ltd.

Add.: No. 278, Shizhu Road, Chengnan Sub-district, Tonglu County,
Hangzhou, Zhejiang, China
E-mail: info@solaxpower.com

